

Technical Information • Installation Instructions

MG40-ZM-L-LN

Gas

March 2024 edition

In the interests of continuous product improvement, technical specifications are subject to change without prior notice!

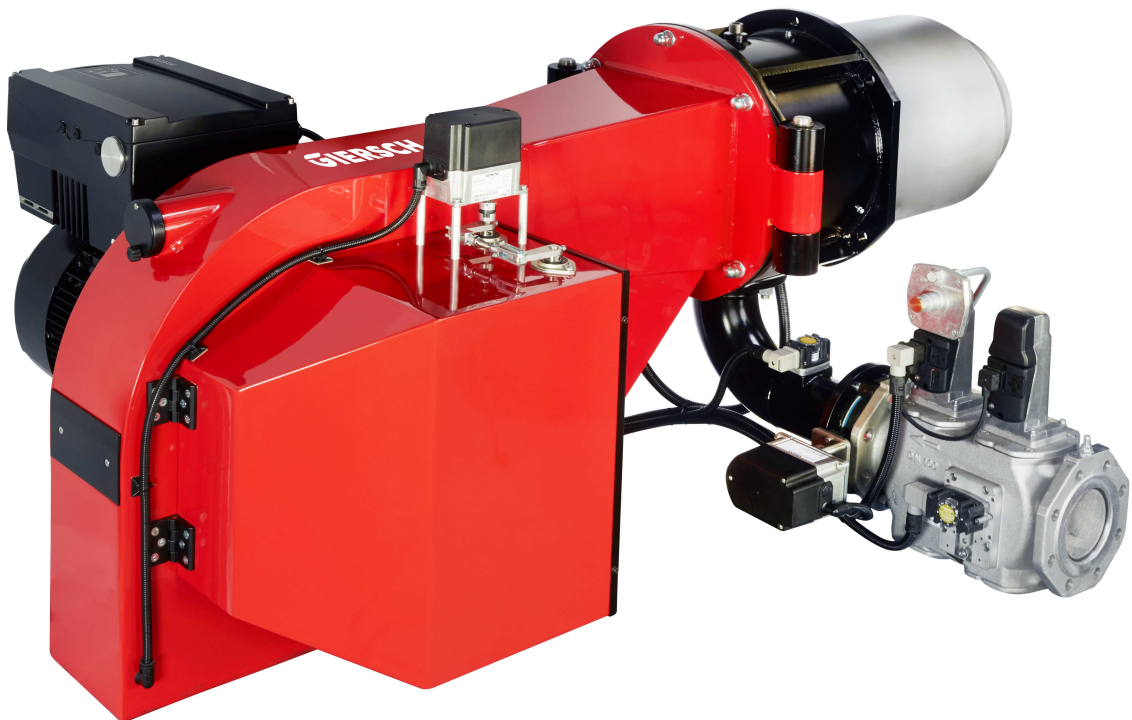

Declaration of Conformity for Gas Burner



Wärme für die Zukunft.

Giersch GmbH | Adjutantenkamp 18 | 58675 Hemer

© 0 23 72/965-0 ☎ 0 23 72/6 1240 ✉ info@giersch.de 🌐 www.giersch.de

Declaration of Conformity for Gas Burners

We, Giersch GmbH, Adjutantenkamp 18 in D-58675 Hemer declare under our responsibility that

gas burner type **MG40/...**

is conform with the regulations of these directives

MD2006/42/EG
EMV2014/30/EG
GAD 2016/426/EG
MCP2015/2193/EU
RoHS 2011/65/EU
DIN EN 676

and is marked with:



CE-0085

Hemer, 12.01.2024

Dr. Josef Becker
Managing Director

Geschäftsführer: Dr. Josef Becker | Vorsitzende des Aufsichtsrates: Helene Richmond | Amtsgericht Iserlohn: HRB 8776 | USt-IdNr.: DE 815685219
Bankverbindung: Giersch GmbH | IBAN: DE44 2004 0000 0240 0703 00 | BIC: COBADEFFXXX | Commerzbank AG | Hamburg

Contents	Page
1	Safety-relevant information 4
1.1	Symbols 4
1.2	General information on safety 4
1.3	Limits 5
1.4	Intended use 5
1.5	Restriction of liability 6
1.6	Qualified personnel 6
1.7	Transport and intermediate storage at installation location 7
1.8	Behaviour if there is a smell of gas 7
1.9	Hazards when handling electrical current 7
1.10	Behaviour in the case of an emergency 7
1.11	Atmospheric explosion protection (ATEX) 7
1.12	Recycling and disposal 7
2	Technical Specifications 8
2.1	Technical data 8
2.2	Type code 8
2.3	Working ranges 8
2.4	Gas train dimensions 9
2.5	Selection diagram for gas fitting 9
2.6	Dimensions 10
3	Burner assembly 11
3.1	Installing the gas jacket at the boiler 11
3.2	Gas mixer head adjustments 12
3.3	Electrodes 12
3.4	Gas fitting installation 13
3.5	Installing the burner housing at the gas jacket 13
3.6	Swivel position / service position 14
4	Electrical installation 15
4.1	Air / gas actuator 15
4.2	Air pressure monitor 15
4.3	Gas input pressure min. with leakage check 16
4.4	Gas pressure switch max. 16
4.5	Flame monitor with ionisation 17
4.6	Connection diagram for connector assignment 18
4.7	Burner management system LMV 19
5	Adjustments 20
5.1	Gas supply 20
5.2	Setting tables 21
5.3	Principles of calculation for gas burner adjustment 23
6	Commissioning 24
6.1	Prior to commissioning 24
6.2	Operation and device description 25
6.3	LMV programming 26
6.4	Adjustment protocol - first commissioning 33
6.5	LMV phase display / operating display 34
7	Backup / Restore 35
8	Manual performance (manual performance request) 38
9	Decommissioning 39
10	Maintenance 39
10.1	Prior to maintenance 40
10.2	Maintenance positions 40
10.3	Maintenance schedule 41
11	Information 42
11.1	LMV fault code list 42
11.2	Exploded view / spare parts list 46

1 Safety-relevant information

This document is part of the product. It must be trained over the entire lifetime of the product. Make this document available to the operator or personnel responsible for activities describe in it. Incorporate supplements that you receive later from GIER SCH to the documents.

1.1 Symbols

Particularly important information is highlighted using corresponding symbols in this document:

Warning



The work safety symbol marks safety information that is intended to prevent danger to life and limb. Observe this safety information carefully and take special care when carrying out relevant work or procedures.

Warning! Danger of fatal injury from electric shocks!



The electrical symbol marks safety information that is intended to prevent danger to life and limb caused by an electric shock. Observe this information carefully and take special care when carrying out the work or procedures described.

Caution



The caution symbol marks all safety information that is intended to prevent damage or destruction of the product and/or other plant components.

Note



Particularly useful information or notes can be found here.

1.2 General information on safety

The chapter on "Safety" provides an overview of the safety aspects that must be observed to ensure safe working with the product described. All persons who assemble, fit or install the product described, commission it or operate and/or service it must read this chapter carefully and observe the instructions in order to prevent injury or property damage. It is all about your safety.

In addition to this general information, the product documentation provides specific safety information for individual actions.

Only if you observe all safety instructions, can you achieve optimum protection for yourself, your colleagues and the environment through safe and reliable operation of the product.

Also be sure to heed the national accident prevention and safety regulations.

1.3 Limits

The following products (in addition to the burner) apply as further subsystems in the plant:

- Heat generator / air supply / exhaust system
- Fuel supply system (gas train / oil supply system)
- Burner control
- Further plant components that do not belong to the burner (e.g. acoustic insulation system, emission-reduction systems)

These subsystems are required to operate the plant; however, they are not part of the burner described in this document and may differ depending on the plant. This burner documentation, therefore, does not contain concrete contents relating to further subsystems of the plant.

It is assumed that the burner and the other subsystems are installed properly and have been electrically connected, and that the burner is supplied with the correct fuel before they are put into operation. It is also assumed that the further systems are in compliance with the relevant standards / regulations and that they match the burner, and that functional tests have been successfully performed.

All necessary information on installation and electrical connection of the burner is provided in the operating instructions.

The operator must ensure that the country-specific accident prevention and safety information is observed. The operator must also ensure that the working environment (e.g. boiler house) is compliant with the regulations. We recommend that the operator should produce operating instructions that cover the entire working environment. This document and all other manufacturer documentation for the plant components should serve as a basis for these instructions.

1.4 Intended use

The burner is intended exclusively for the generation of heat by combustion of the fuel specified on the type plate in conformance with the performance data specified in the technical specifications.

The burner must be used in a matching plant environment (fuel management system, heat generator, etc.) (see section 1.3).

The energy produced by the burner must be removed, also during commissioning.

To guarantee proper functioning of the burner, a negative pressure compared to the atmosphere must not prevail at the installation location. The intake opening of the blower must be free to allow sufficient intake of air.

Before the burner can be used for standard operation, its firing must be commissioned. This commissioning procedure must only be performed by a firing technician (see "Qualified personnel").

The firing technician is responsible for ensuring that proper combustion is achieved in all output stages and that all safety equipment (safeguards, etc.) and controllers are set correctly. All values set must be documented in an acceptance and test report and made available to the operator.

The adjustments made during commissioning must not be modified afterwards. Exception: If the operating conditions change at a point in time after commissioning (due to changes in the fuel characteristics or plant environment for example), a firing technician must check the adjustments and adapt them where necessary. The set values must be redocumented in an acceptance and test report.

The burner is equipped with safety devices and has been tested and inspected for safety. It may only be operated if all safety devices have been set properly and are in operation. The safety equipment includes the safety chains and all components, all other safeguards as well as protective design measures, such as barriers and warning signs.

It is forbidden to modify the safety equipment or put it out of operation, unless it is expressly instructed in the documentation to deactivate and/or remove such equipment for a short period. If this is necessary during maintenance, for example, it must be fitted and/or activated again before the burner is restarted. As a rule, warning signs must not be covered or removed.

Conversion measures are permissible only with written approval from GIERSCH. Install only additional components that have been tested together with the device; do not use combustion room inserts that would hinder burn-out of the flame, use only GIERSCH original components.

The instructions and regulations in the documentation must be observed in a lifecycle phases of the burner. This applies in particular for maintenance of the burner (observance of deadlines for inspection and maintenance work, and for the exchange of safety-relevant components).

The plant must be checked in its entirety by the manufacturer and/or authorised and trained personnel once a year for reasons of operational safety and economy.

We recommend that a maintenance contract be concluded. GIERSCH Service will be pleased to provide further information.

1.5 Limitation of liability

Any use that deviates from the conditions stated above shall be deemed improper use. GIERSCH shall not be held liable for any damage that results from improper use. The risk in this case shall be borne solely by the operator / owner.

1.6 Qualified personnel

Warning!



Risk of injury and property damage due to incorrect operation!

The operator must ensure that only qualified personnel work with the product.

Qualified personnel in the context of this documentation are persons who have completed qualifying training on the handling of the product described, ideally trained by GIERSCH and authorised by the operator of the plant to assemble, commission operate and/or service the product.

The burner may only be commissioned by a firing technician. Training for the burner shall be provided by GIERSCH, training for the other plant components by the relevant manufacturers.

1.7 Transport and intermediate storage at the installation location



Warning! Risk of injury from burner falling down!

If a burner falls down, this can cause most serious injuries! Be sure to observe the instructions for transport and storage.



1.8 Behaviour if there is a smell of gas

- Prevent open fire and sparks, e.g.:
- Do not switch lights on or off.
- Do not operate electrical devices.
- Do not use mobile telephones.
- Open windows and doors.
- Close the gas ball valve.
- Warn house occupants; do not operate doorbells.
- Exit the building.
- Outside the building, notify the heating specialist or gas supply company.

1.9 Hazard when handling electric current



Warning! Danger of fatal injury from electric shocks!

If the insulation is damaged or live components are not covered properly, life is at risk due to electric shock!

Warning! Danger of fatal injury from electric shocks!



Carelessness can result in an electric shock.

Therefore, always carry out the following steps when performing work on electrical devices:

- De-energise the devices.
- Secure to prevent them from being switched on again.
- Check that they are de-energised.
- Ground and short-circuit the devices.
- Cover neighbouring, live components/devices.
- Cordon off the danger zone and/or position a noticeable, readily visible warning sign.

1.10 Behaviour in the case of an emergency



In the event of danger:

Actuate the plant's "emergency stop switch" and interrupt the fuel supply!

1.11 Atmospheric explosion protection (ATEX)

If the product is to be used in a potentially explosive area, the operator must ensure that it is incorporated in a coherent explosion protection concept that complies with Directive 1999/92/EC.

1.12 Recycling and disposal

Leave disposal of the packaging up to the specialist who installed the product.

Notes on disposal:

If the product is marked with this sign:



- Do not dispose of the product as household waste in this case.
- Hand it over to a collection point for old appliances instead.
- Disposal and recycling must take place in compliance with local and national regulations at commissioned and authorised collection points or disposal sites.

2 Technical specifications

2.1 Technical specifications

Technical specifications	Burner type	
	MG40/1-LN	MG40/2-LN
Burner output in kW	484 - 4500	611 - 6300
Gas type	Natural gas LL + E = „N“	
Perm. operating pressure	200 - 700 mbar	
Mode of operation	2-stage/modulating	
Voltage	3 / N / PE ~ 50 Hz 400 V / 230 V	
Fuse	400 V = 32 A	
Current consumption during operation in A	20	27
Electric motor (at 3000rpm) in kW	11	15
Flame control	Ionisation	
Burner management system	LMV27	
Weight in kg	346	
Noise emission in db(A)	86	87
Degree of protection	IP40	
Emission class	3	
NOx limit value	≤ 80 mg/kWh	

2.2 Type code

MG 40/1-ZM-L-N-LN

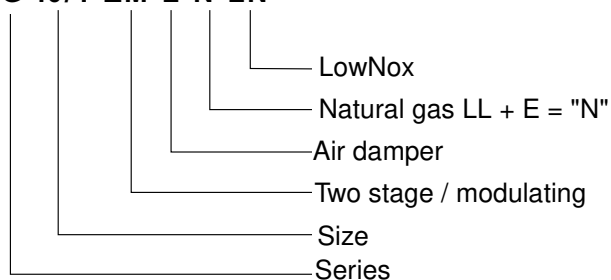

2.3 Working ranges

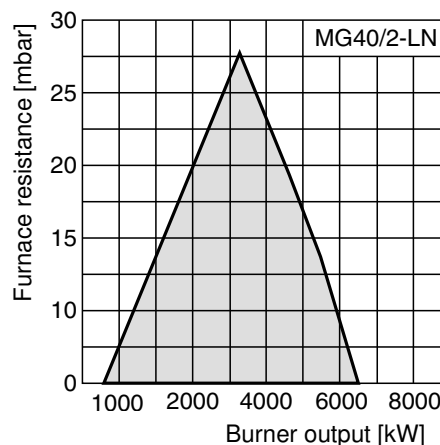
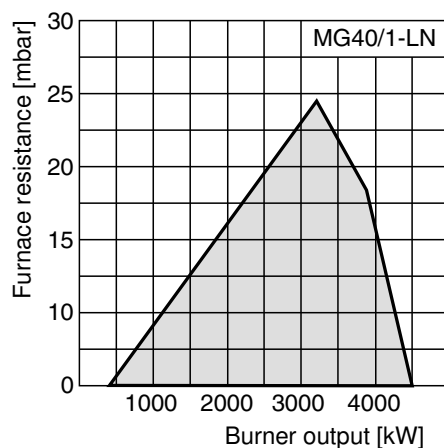

Working ranges according to DIN EN 676 2008-11. The working ranges are referred to 15°C and 1013 mbar.

2.4 Gas train dimensions

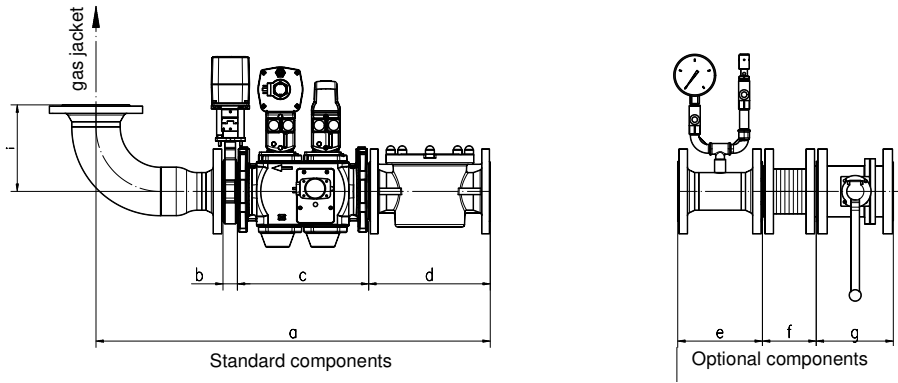

Designation		KEE 2"	KEE DN65	KEE DN80	KEE DN100
a	Gas fitting	approx. 705	approx. 705	approx. 705	approx. 705
b	Gas throttle	30	30	30	30
c	Double gas valve	240	290	310	350
d	Gas filter	230	290	310	350
e	Manometer/test burner optional	approx. 120	215	200	205
f	Compensator	approx. 250	110	125	150
g	Ball valve	approx. 130	170	180	190
i	Connecting bend	205	205	205	205

2.5 Selection diagram for gas fitting

MG40/1-LN

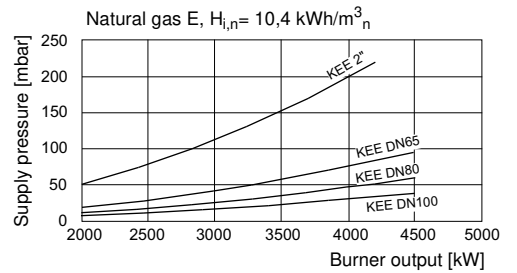
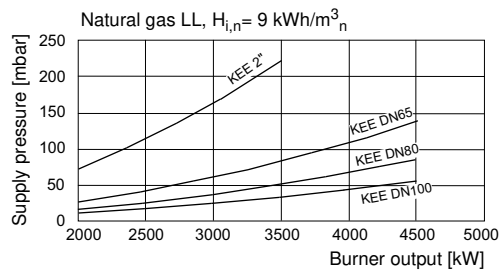

MG40/2-LN

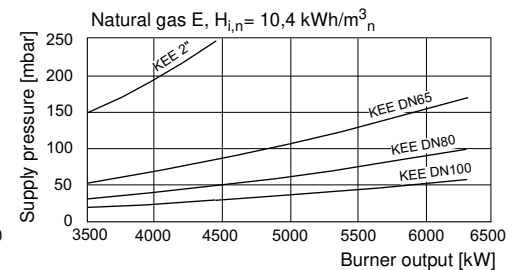
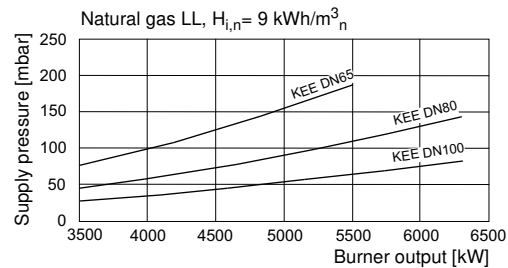

2.6 Dimensions

All dimensions are given in mm

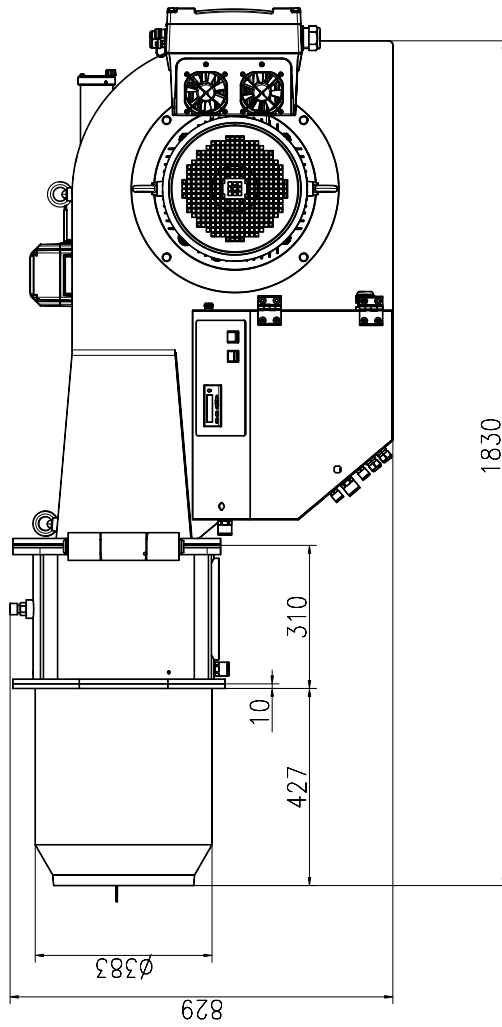
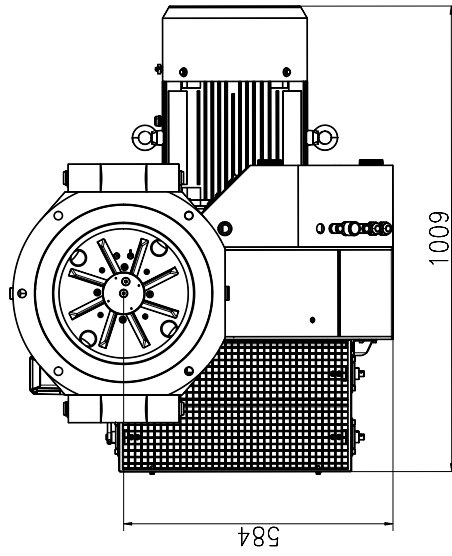

3 Burner installation

3.1 Mounting the gas jacket on the boiler

The boiler connection plate must be prepared according to the dimensions specified for the boiler connection dimensions. You can use the gas-jacket gasket as a template.

Screw the gas jacket to the boiler using the four M10 fastening screws with washers and a size SW8 Allen key.

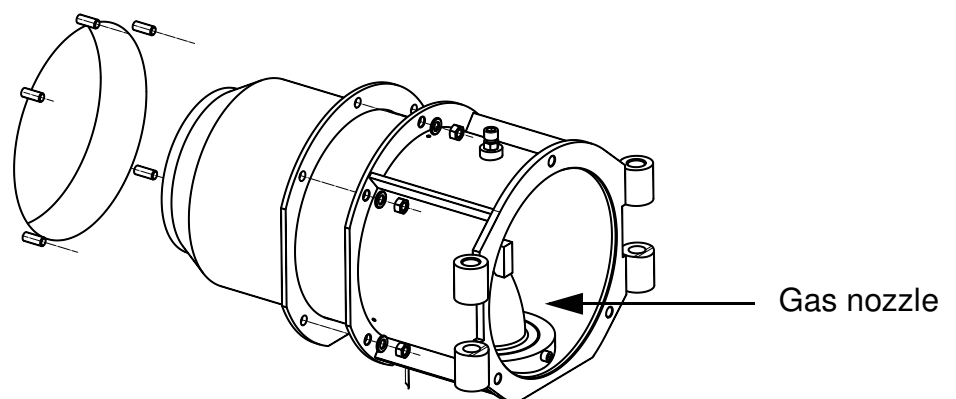
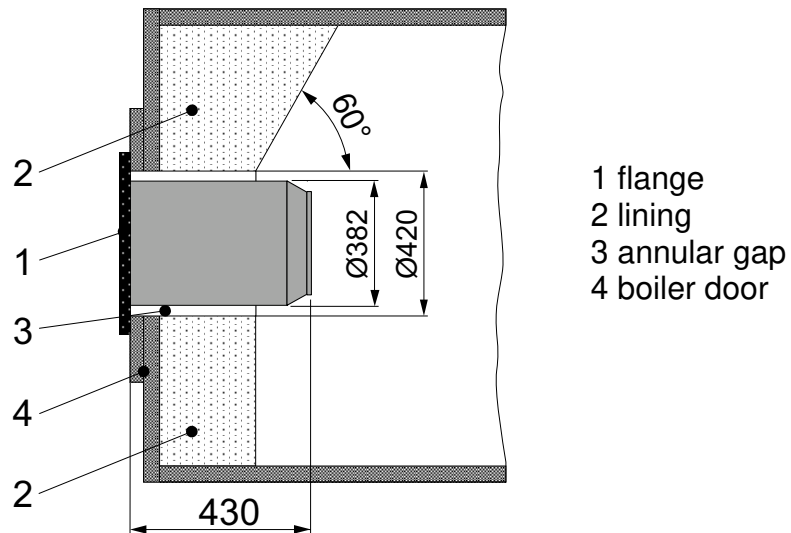

3.2 Settings for gas mixer head

The position of the mixing head (dimension "B") is preset at the factory. .

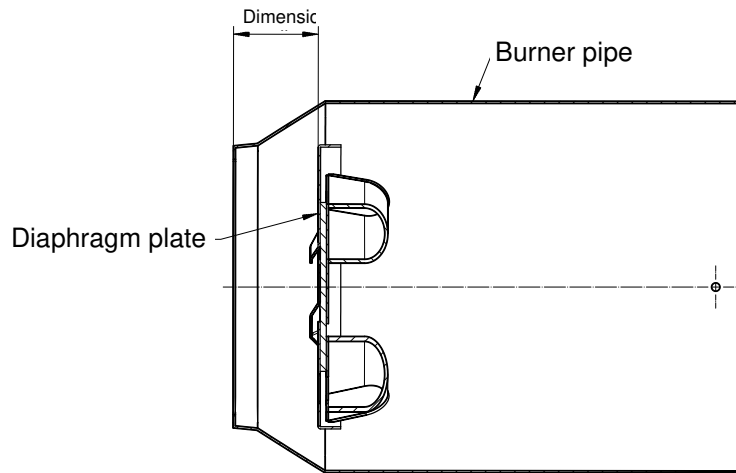

3.3 Electrodes

The electrodes are preset at the factory.

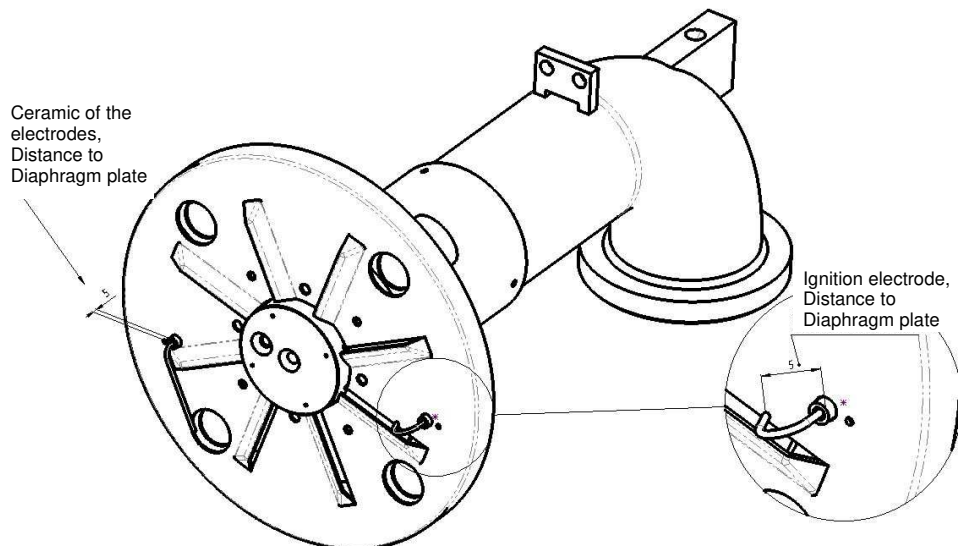
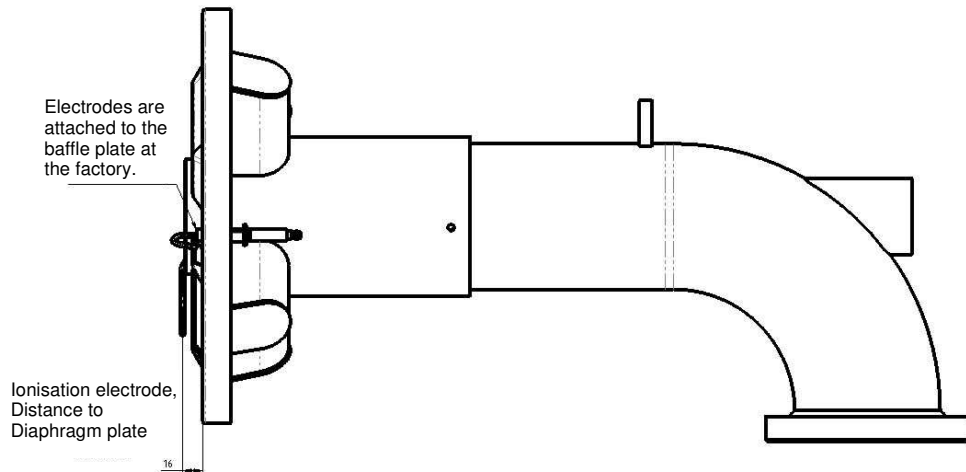

3.4 Gas fitting installation

Installation position of the gas fitting

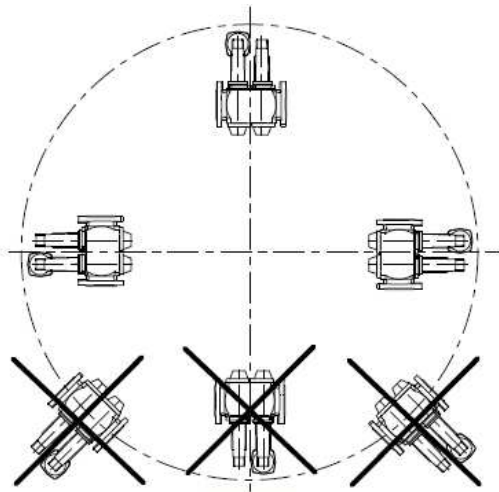

3.5 Mount the burner housing at the gas jacket

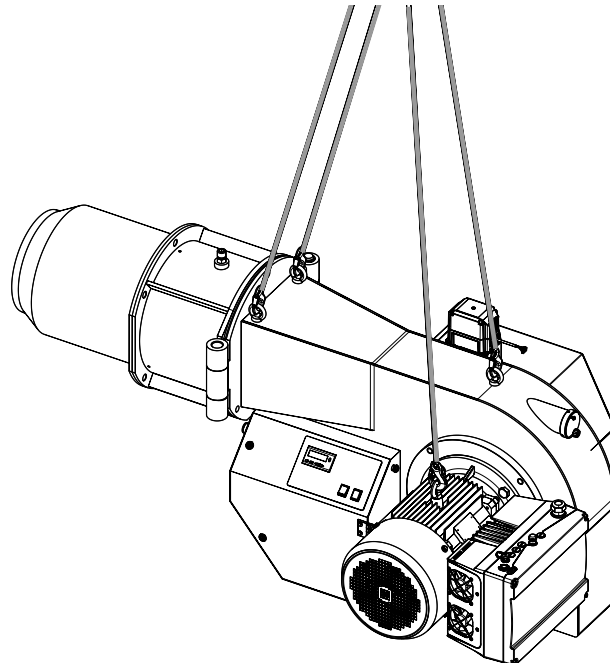

Position the burner housing in the gas-jacket hinge and secure it with a rod. The burner is now in the service position.

Attach the ignition and ionisation cable to the ignition and ionisation electrodes.

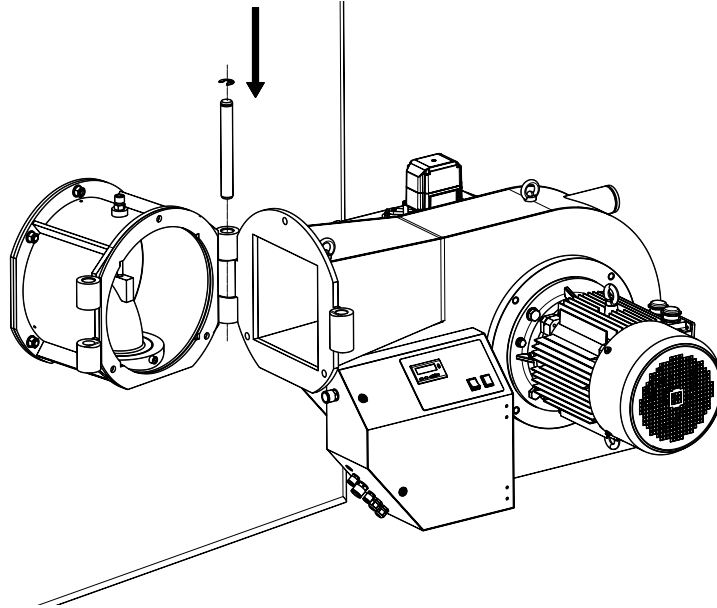

Carefully swing the burner closed. Do not pinch electrical cables.

Secure the burner housing with the fixing screws (3 x M16).

3.6 Swivel position / service position

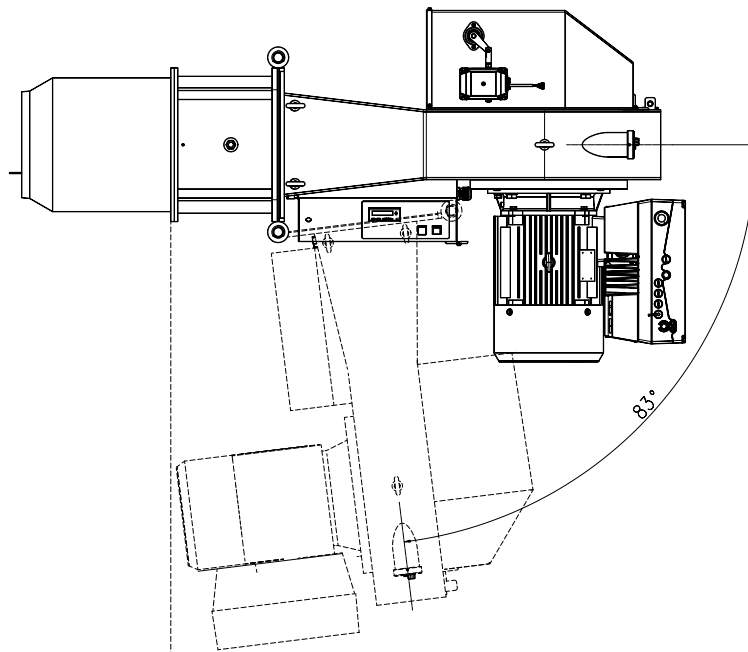

4 Electrical installation

4.1 Air / gas actuator

The air actuator is designed for air flap adjustment on progressive two-stage burners or modulating burners.

The gas actuator is designed for gas flap adjustment on progressive two-stage burners or modulating burners.

They are controlled electronically via the burner management system.



Do not open the burner under voltage. The internal optics would be destroyed. No warranty if the seal is broken!

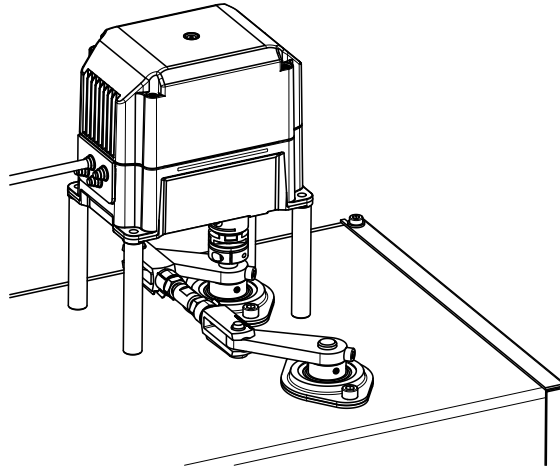

4.2 Air pressure monitor

The air pressure switch is a differential pressure switch and monitors the air pressure at the forced-air burner. The air pressure switch is pre-set at the factory.

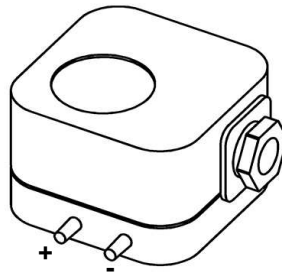

4.3 Gas pressure switch min. with leakage check

The gas pressure switch at the gas train serves to monitor the gas input pressure and test the valves for leaks. The gas pressure switch must be set to 50% of the static gas input pressure.

4.4 Gas pressure monitor max.

Optionally a gas pressure switch max. can be incorporated.

The LMV and the wiring have been prepared such that only the jumper in the socket part (brown) at the burner needs to be removed. In addition, the male connector and the gas pressure switch max. must be wired in accordance with the circuit diagram. If the gas pressure switch max. has tripped, a fault is shown in the display (AZL).

First, the gas pressure switch max. must be unlocked; to do this the lid of the gas pressure switch max. must be unscrewed and the red button pressed. Then, the fault in the display can be deleted (press the **i/reset** button for 3 sec.).



The switching point must be adjusted such that it corresponds to half of the input flow pressure.

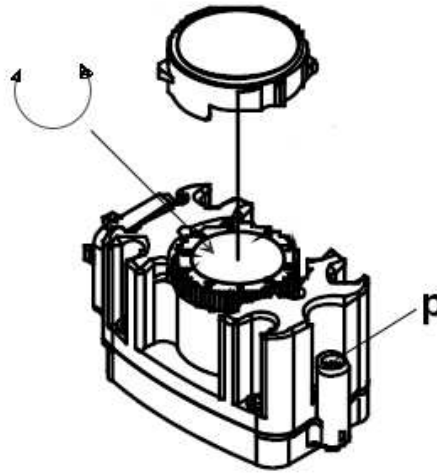

4.5 Flame monitoring with ionisation



When a flame is present, an ionisation current flows between the electrode and the LMV burner management system. The ionisation current produces the flame signal.

The ionisation current must be measured during commissioning or maintenance. To do this, disconnect the connector in the ionisation cable and connect the current meter series.

The required minimum probe current is $2.3 \mu\text{A DC}$, the maximum possible probe current is DC $\mu\text{12... 30 A}$.

If the ionisation current is too small, this results in a fault shut-down. In this case, ionisation rod and the diaphragm plate must be cleaned. If necessary, re-bend the ionisation rod. If the ionisation rod is defective, replace it. Check the cable for moisture and dry if necessary.



Check the polarity of the supply cable (L1 and N)

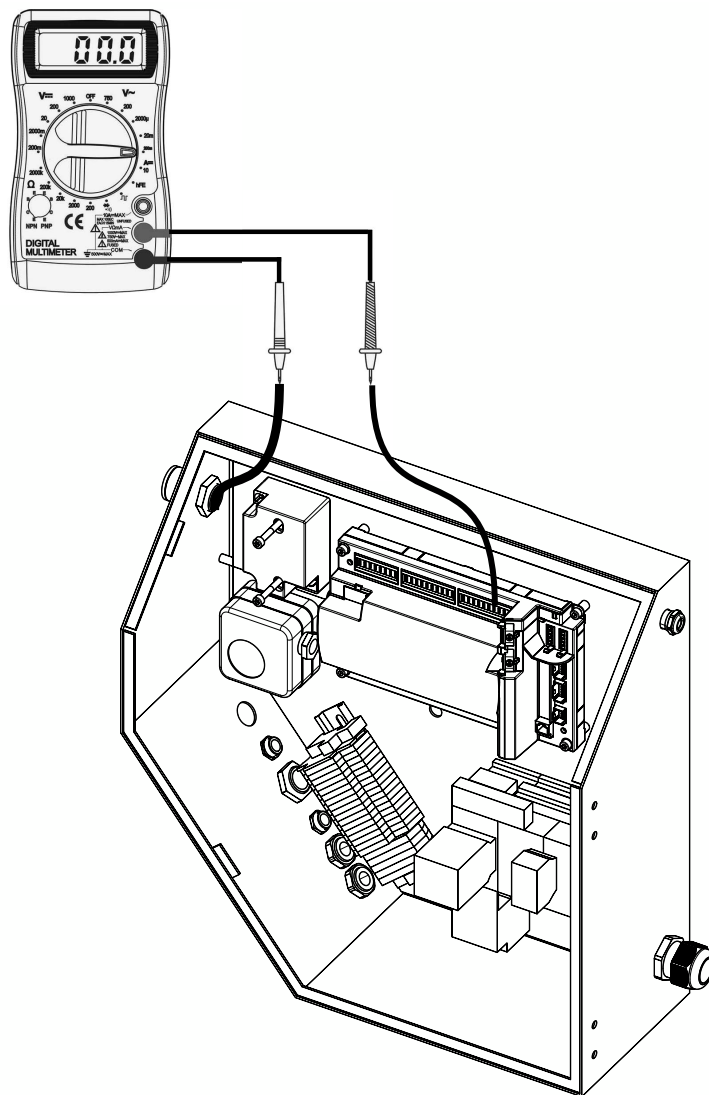

4.6 Terminal diagram - connector pin assignments



If the connectors have already been pre-wired: check the connections in accordance to the connection diagram!

The electrical connection of the burner must be made in the connectors included according to the connection diagram, taking account of the local regulations. The supply cable must be fused with max. 10 A fast blow or 6.3 A slow blow and must be routed using flexible cable.

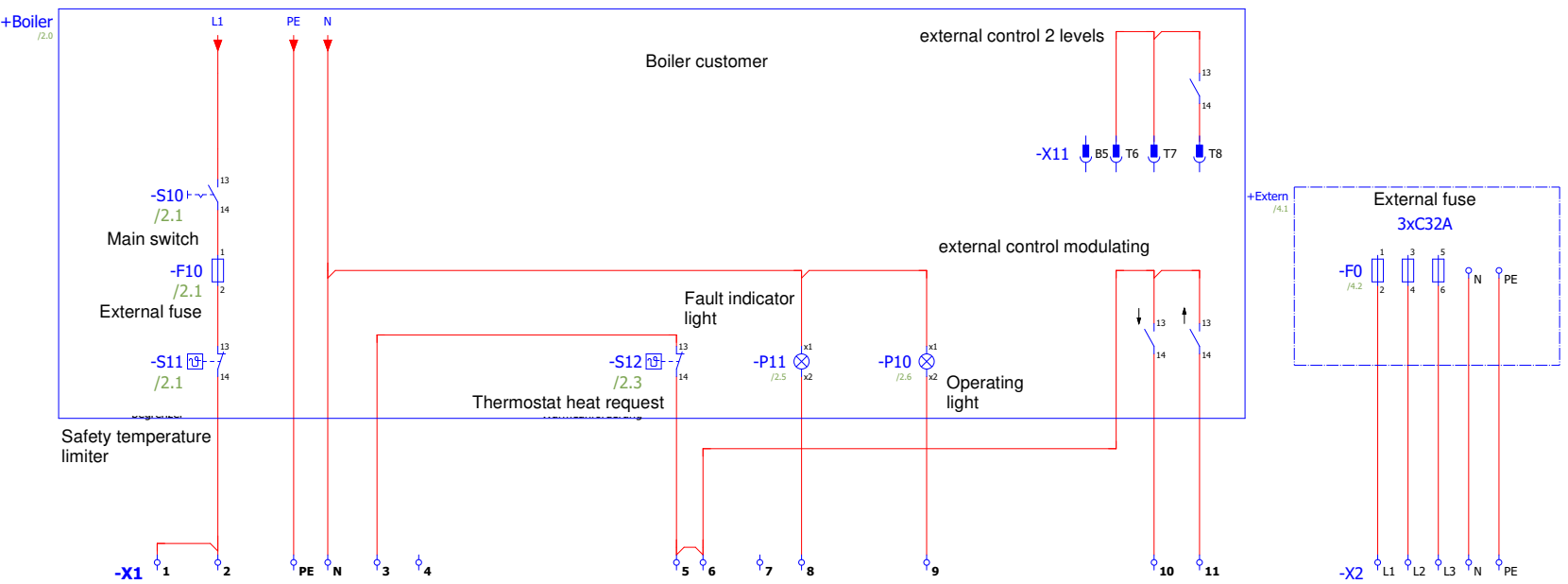

4.7 LMV burner management system

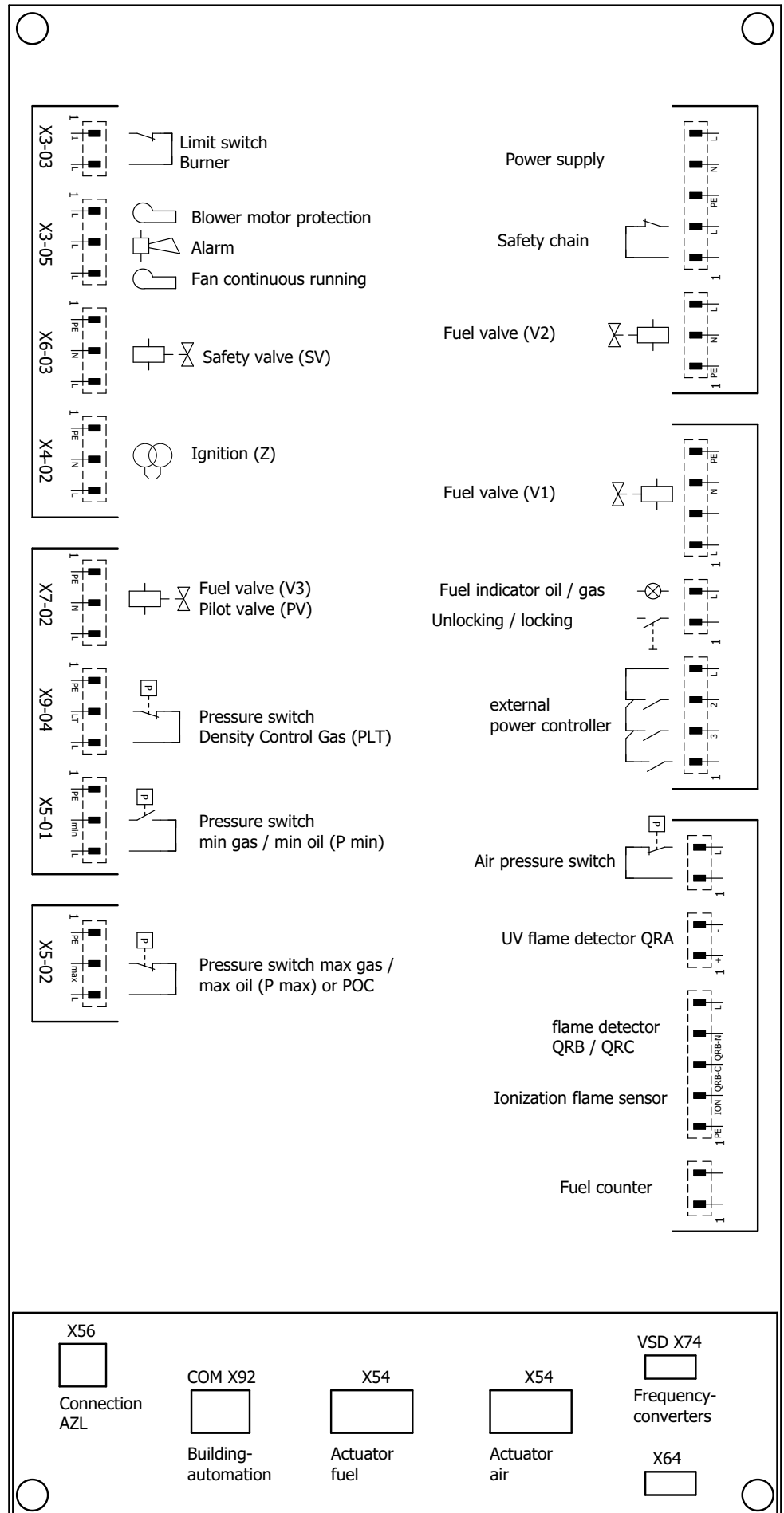

5 Settings

5.1 Gas supply

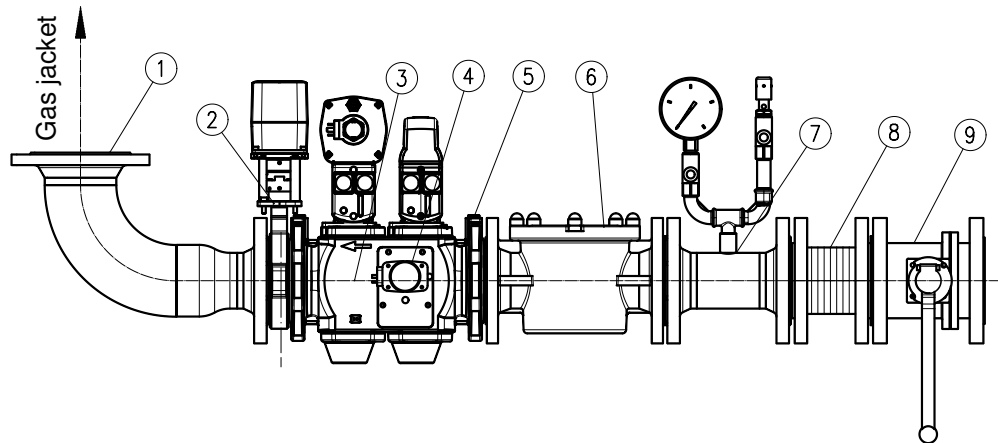

① Connecting bend

② Gas throttle

The gas throttle regulates the quantity of gas according to the power required. It is controlled by the burner management system using an actuator.

③ Double gas valve

The double gas valve opens and blocks the gas supply automatically. The leakage check for the gas pressure switch is located between the valves.

④ Gas pressure switch min. - leakage check

The gas pressure switch min. **leakage check** check the gas connection pressure. If the specified gas pressure is undershot, the gas deficiency program starts. It checks whether the valves are tight and signals to the burner management system if the pressure rises or falls to an impermissible value during a leakage check.

The leakage check is performed automatically by the burner management system:

- After normal shutdown,
- Prior to burner start,
- After a fault shut-down,
- After a power failure.

⑤ Gas pressure switch max. (option)

If the gas pressure exceeds the set level, the gas pressure switch -max at the burner management system triggers a safety shutdown.

The gas pressure switch -max is polled with a delay during commissioning of the burner. Pressure that may have accumulated can be removed during this time.

⑥ Gas filter

The gas filter protects the downstream train against dirt particles.

⑦, ⑧, ⑨ Optional components

- ⑦ **Manometer/test burner**
- ⑧ **Compensator**
- ⑨ **Ball valve**

5.2 Adjustment tables

The values specified in the tables are only reference inputs for start-up. The system settings required in each case must be redefined if values such as boiler output, calorific value and altitude deviate.

A correction is required in any case.

The maximal burner output can only be achieved in mixer head position 0. Due to the variable mixer head position, the operating behaviour of the burner can be optimised for different heat generators.

5.3 Calculation principles for gas burner adjustment

The values given in the tables are setting values for start-up. The necessary system adjustment must be newly determined in each case.

General:

The calorific value ($H_{i,n}$) of fuel gases is generally specified for the normal state (0°C, 1013 mbar).

Natural gas E $H_{i,n} = 10.4 \text{ kWh/m}^3$
 Natural gas LL $H_{i,n} = 9.3 \text{ kWh/m}^3$

Gas meters measure the volume of the gas in the operating state.

Gas flow determination:

To allow the heat generator load to be adjusted correctly, the gas flow rate must be determined in advance.

Example:

Height above sea level 230 m
 Barometric air pressure B (acc. to. table) 989 mbar
 Gas pressure P_G at counter 20 mbar
 Gas temperature ϑ_G 16°C
 Boiler output Q_n 220 kW
 Efficiency η_K (assumed) 92%
 Calorific value $H_{i,n}$ 10.4 kWh/m³

Gas flow in standard state (V_n)

$$V_n = \frac{Q_n}{\eta_K \times H_{i,n}} = \frac{220 \text{ kW}}{0,92 \times 10,4 \frac{\text{kWh}}{\text{m}^3}} = 23 \frac{\text{m}^3}{\text{h}}$$

Gas flow in operating state (V_B)

$$V_B = \frac{V_n}{f} = \frac{23 \frac{\text{m}^3}{\text{h}}}{0,94} = 24 \frac{\text{m}^3}{\text{h}}$$

Conversion factor (f)

$$f = \frac{B + P_G}{1013} \times \frac{273}{273 + \vartheta_G}$$

Annual average air pressure

Average geodetic altitude of the supply region above sea level [m]	from to	0	50	100	150	200	250	300	350	400	450	500	550	600	650	700	750
Annual average of air pressure	(mbar)	1016	1013	1007	1001	995	989	983	977	971	965	959	953	947	942	936	930

Key:

Q_n = Boiler output [kW]
 η_K = Efficiency [%]
 $H_{i,n}$ = Lower standard calorific value [kWh/m³]
 f = Conversion factor
 B = Barometric air pressure [mbar]
 P_G = Gas pressure at gas meter [mbar]
 ϑ_G = Gas temperature at gas meter [°C]

6 Start-up

6.1 Prior to commissioning

General information

Installation of a gas-fired heating system must be performed in accordance with the applicable regulations and guidelines. It is therefore the duty of the installer to be familiar with all applicable regulations and requirements. Installation, start-up and maintenance must be performed with utmost care.

The burner must not be operated in rooms with high levels of air humidity, dust or corrosive vapours. The boiler room must be ventilated accordingly with ventilation air.

Giersch MG Series gas burners are suitable for combustion of natural gas or liquid gas in accordance with DIN EN 437 and are in compliance with the DIN EN 676 European standard.



The following points must be checked prior to commissioning.

- Check voltage,
- Check direction of rotation of the motor,
- Gas pressure upstream of gas fitting,
- Gas tightness of gas train,
- Check fresh air supply.

Instruction of operating personnel





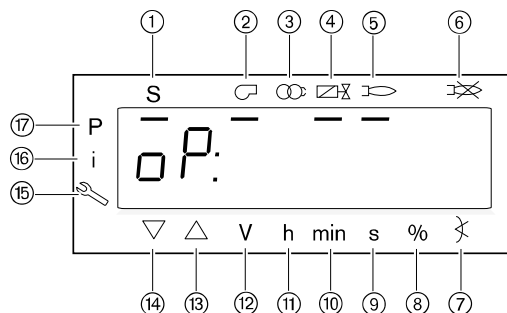

Failures are often caused by operator error. The operating personnel must be properly instructed in how the burner works. In the event of recurring faults, Customer Service should be notified.

6.2 Operation and device description

The black bar in the display indicates the status of the inputs and outputs, the unit for the values and the active level.

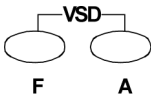

- 1 Heat request from boiler control (start)
- 2 Burner motor
- 3 Ignition
- 4 Fuel valves
- 5 Flame signal on
- 6 Flame failure or fault
- 7 Angle adjustment
- 8 Percentage value
- 9 Second
- 10 Minute
- 11 Hour (together with volume = V/h)
- 12 Volume (m³, l, ft³, gal)
- 13 Actuator OPEN
- 14 Actuator CLOSE
- 15 Service level
- 16 Information level
- 17 Parameter level (heating technician level)

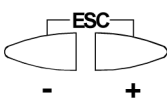
Button	Function
 F	F button - To adjust the fuel drive (Hold down the F button and set the value with the - or + button)
 A	A button - To adjust the air drive (Hold down the A button and set the value with the - or + button)
 F A	F and A button - To shift to parametrisation mode P (F and A button press simultaneously with - or + button) - To adjust the speed for frequency converter operation (FC) (F and A button press simultaneously with - or + button)
 i/reset	Information and enter button - To navigate in information and service mode * Selection (flashing symbol) increment (press button < 1 s) * To switch to a lower menu level (press button < 1 ... 3 s) * To switch to a lower menu level (press button < 3 ... 8 s) * To switch the operating mode (press button > 8 s) - Enter in parametrisation mode - Unlock in case of fault - One menu level down
 -	- Button - Reduce value - For navigating in curve setting, information and service mode
 +	+ Button - Increase value - For navigating in curve setting, information and service mode
 - +	- and + button: Escape function (Press - and + button simultaneously) - Do not accept the value - One menu level higher

6.3 LMV programming

Burner cold adjustment

Determining burner output according to adjustment table.

P0 = Starting level, P1 = 1st level / min. output, P9 = 2nd level / max. output



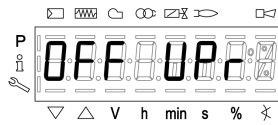
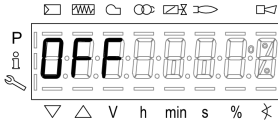

Normally, P0 = P1. For the condensing boiler, P0 must be set higher than P1. The setting is dependent on the boiler. The mixer head must be set according to the table.

To enter this adjustment mode, the burner must be on standby. Standby means that the burner is supplied with voltage, gas pressure is built up and there is no demand for heat.

The LMV burner management system is parameterised at the factory. **OFF** appears in the display during first start-up.

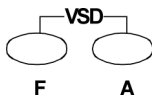
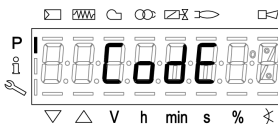
Action button	Display	Description
		OFF UPr means burner off and non-programmed.
		OFF means burner off and programmed.

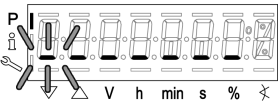
Enter password

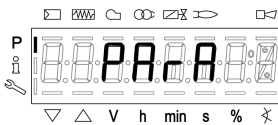
Action button	Display	Description
		Press F and A button simultaneously. The display Code appears
 		After releasing the buttons, 7 bars appear and the first one flashes. Use the - or + button to select a number or letter. Confirm each value with i/reset .
		Confirm the password 1234 with i/reset after the last input.
		After correct input, the following appears for a max. of two seconds

Switch on the burner

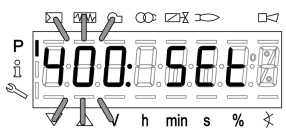
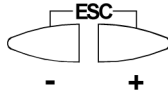
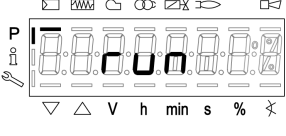





Action button	Display	Description
 i/reset		Initial commissioning and network setting
 ESC		When the LMV is programmed, run is displayed. (Start detection for curve parameterization)

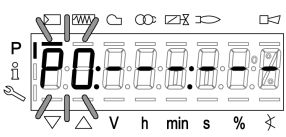

You can continue with warm setting (page 29) by pressing **i / Reset**.

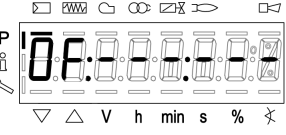
Adjustment without flame

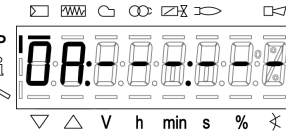

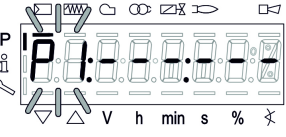
Cold preset

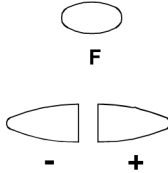
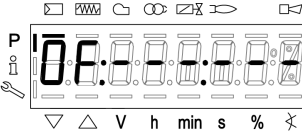
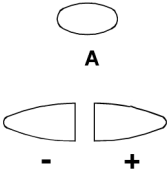
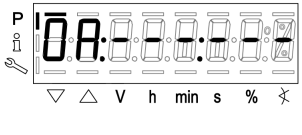
Use the values from the setting table for the presetting. In the default setting, the maintenance switch should be in position 0





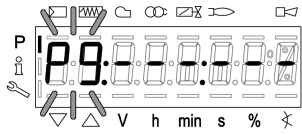
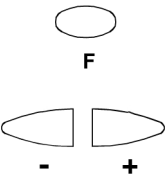
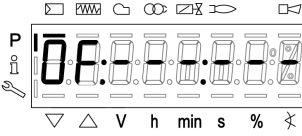
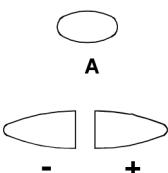
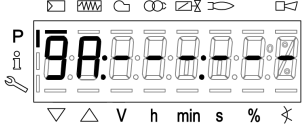

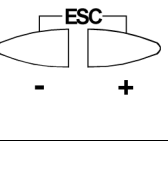
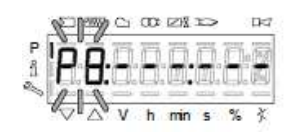
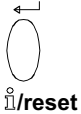
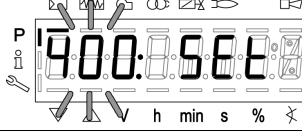

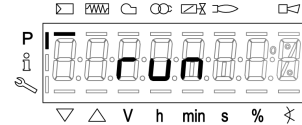

Action button	Display	Description
		Set the starting position of the air flap.
 F		Hold down the F button and use the - or + button to set the gas supply value to adjust
 A		Hold down the - A button and press the - or + button to set the air supply value to adjust. Usually P0 = P1. For condensing boilers, P0 must be set higher than P1. The setting depends on the boiler.
 +		Move to the next curve point.
		Set curve point P1

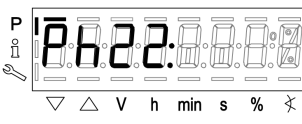

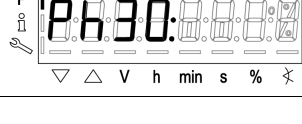



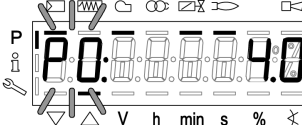

Action button	Display	Description
		Hold down the F button and use the - or + button to set the gas supply value to adjust
		Hold down the - A button and press the - or + button to set the air supply value to adjust.
		Set the remaining curve points up to P9 using the same procedure.

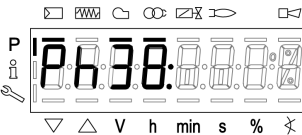
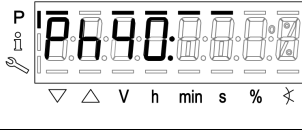

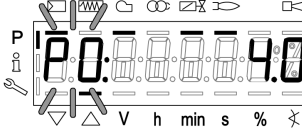

High load preset

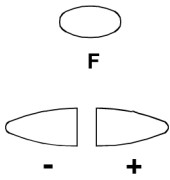
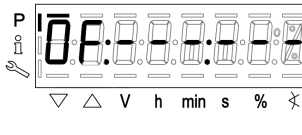
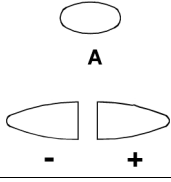
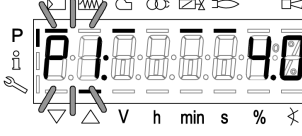
Action button	Display	Description
		Adjust heavy load air flap.
		Hold down the F button and use the - or + button to set the gas supply value to adjust
		Hold down the - A button and press the - or + button to set the air supply value to adjust.
		The - button for longer than 3 seconds. Press and hold to trigger the calculation (CALC). Points p8 to P1 are calculated automatically and placed on a straight line.
		Press the ESC button to return to the parameter level.
		Press the i/Reset button







Warm setting, adjustment with flame
Start identifier for curve programming

Action button	Display	Description
 i/reset		Run Gas is displayed. Press the i / reset button to start the burner
		Burner starts with pre-ventilation.
Maintenance switch 0/1		Heat request ON Burner starts with pre-ventilation
		Blower start-up and safety valve ON
		Run in pre-ventilation position
		Pre-ventilation
If the leakage check is activated, Ph80, Ph81, Ph82 and Ph83 are displayed first.		
		Run in ignition position
		If the phase sequence stops at Ph36 , press the + button .
  		This display only appears if the LMV was originally unprogrammed. Otherwise, it jumps directly from Ph36 to Ph38. The ignition position P0 can only be corrected after the symbols ▼ ▲ go out. Hold down the A button and set the value with the - or + button . Press + button to confirm.

Action button	Display	Description
		Ignition ON
		Valves on
		Ignition OUT
		Flame in start position
		Skip P0 with + button
		Continue to the next curve point P1 low load
		Hold down the F button and set the value with the - or + button
		Hold down the A button and use the - or + button to set the value for the low load to adjust
		<p>Confirm all curve points with the + button until curve point P9 is reached.</p> <p>Check curve points for exhaust gas values. If necessary, adapt the curve points.</p> <p>Hold down the F button and press the - or + button the value for fuel to adjust.</p> <p>Hold down the A button and press the - or + button set the value for air.</p>

Action button	Display	Description
		Select curve point P1 using the button.
		Hold down the F button and press the - or + button the value for fuel to adjust. Hold down the A button and press the - or + button set the value for air.
		Select curve point P9 again with the + button
		Hold down the F button and press the - or + button the value for fuel to adjust. Hold down the A button and press the - or + button set the value for air.

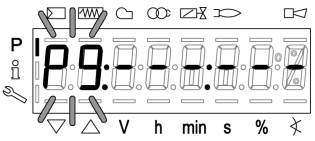
Setting the power in large and small loads

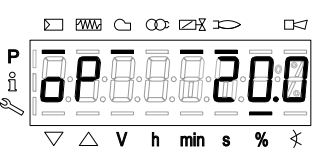
Action button	Display	Description
 <p>A</p>  <p>- +</p>		<p>Check the large load using the gas quantity on the gas meter or by comparing the nozzle pressure with the values ??in the setting tables.</p> <p>A hold down the button and set the power for curve point P9 with the - or + button.</p> <p>The combustion values do not change with this setting</p>
 <p>-</p>		<p>Select curve point P1 using the - button.</p> <p>Check the small load via the gas quantity on the gas meter or by comparing the nozzle pressure with the values according to the setting tables</p>
 <p>+</p>		<p>Back to curve point P9</p>
 <p>- +</p>		<p>After setting all curve points the is Burner ready for use.</p> <p>Press the ESC key three times to save the curve points and to save them in the Automatic mode</p>
		<p>OP 20 ... 100 burner power level (automatic mode)</p>

The warm setting of the burner is complete.

6.4 Adjustment protocol - First commissioning



Please enter the measured values into the Adjustments log.

Boiler type	Gas fitting

Measured values		min.	max.
P0 (start point)			
P1 (min load)			
P9 (max load)			
Flue gas temperature	°C		
Carbon dioxide (CO ₂ level)	%		
O ₂ content	%		
CO level	%		
Flue	mbar		
Nozzle pressure	mbar		
Boiler pressure	mbar		
Room temperature	°C		
Gas type			

Company / Address	Installation date	Signature

6.5 LMV phase display / operating display



Display	Description
Ph00	Fault phase
Ph01	Safety phase
Ph10	Go home
Ph12	Standby (stationary)
Ph22	Blower start-up time (blower motor = ON, safety valve = ON)
Ph24	Run in pre-air position
Ph30	Pre-air time
Ph36	Run in ignition position
Ph38	Pre-ignition phase
Ph39	Leakage check filling time (test pressure switch min for installation between fuel valve 1 and fuel valve 2)
Ph40	First safety time (ignition transformer ON)
Ph42	First safety time (ignition transformer OFF)
Ph44	Interval 1
Ph50	Second safety time
Ph52	Interval 2
Ph60	Operation 1 (stationary)
Ph62	Maximum time small-load setting (operation 2, preparation decommissioning, run in small-load setting)
Ph70	After-burn time
Ph72	Run in post-ventilation position
PH74	Post-ventilation time (no external leak test)
Ph78	Post-ventilation time (abort when power controller ON)
Ph80	Leakage check idle time
Ph81	Leakage check test time atmospheric pressure, atmosphere test
Ph82	Leakage check filling test, filling
Ph83	Leakage check test time gas pressure, pressure test
Ph90	Gas shortage waiting time

7 Backup / Restore







With the help of the AZL2, settings of the LMV26 can be saved (backup) and restored to the LMV27 at a later time.

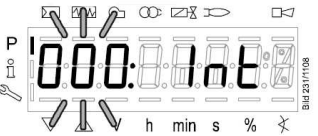
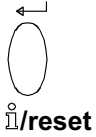

Caution!

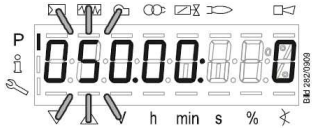
We recommend to perform a backup after a parameter change!!

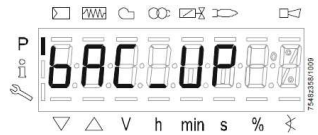
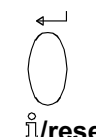
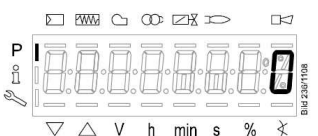
Backup

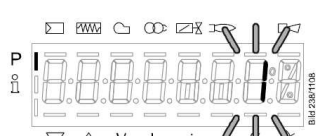
Action button	Display	Description
		Parameter 000: flashes. Display: Parameter 000: flashing, display Int not
		
		Press + key to select parameter 050 . Display: Parameter 050. flashing, index 00: and value 0 not
		
		With i / reset select parameter bAC_UP . Display: Parameter bAC_UP
		
		Press i / reset to select the backup operation. Display: Value = 0
		With the + key, the value in change mode is shifted one position to the left. Display: Value 1 flashes Note To detect display errors, the value is displayed offset to the left

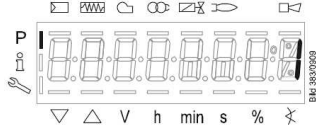
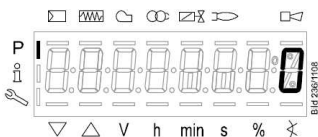
Action button	Display	Description
 i/reset		With i / reset activate the backup process. Display: 1 appears
ca. 5 seconds		After approx. 5 seconds (depending on the duration of the program), the display shows 0 and signals the end of the backup process. Display: 0







Note!

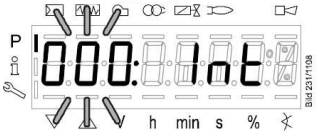

If an error occurs during the backup, a negative value is displayed. For error diagnostics, the cause of the error can be read from the diagnostic code of error message 137 (see error code list).

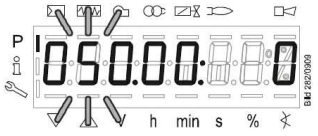
Restore a backup record (Restore)

To restore a backup data set, the parameter must be set to the value 1.

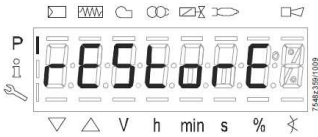
Restore

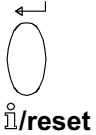
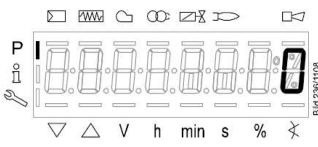
Action button	Display	Description
		Parameter 000 : flashes. Display: Parameter 000: flashes, Int does not.
 i/reset		
		Press + key to select parameter 050 . Display: Parameter 050. flashing, index 00: and value 0 not
 i/reset		
		With i / reset select parameter bAC_UP . Display: Parameter bAC_UP
		Press + key to select the parameter rESTorE . Display: rESTorE

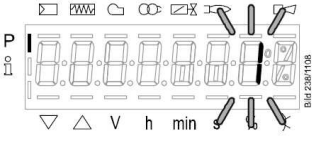
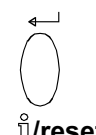
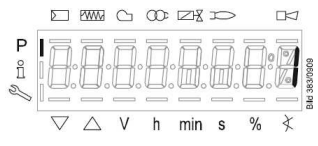
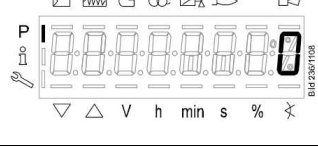
Action button	Display	Description
 i/reset		
		Press i / reset to select the restore operation. Display: value 0
 +		With the + key , the value in change mode is shifted one position to the left. Display: Value 1 flashes Note To detect display errors, the value is displayed offset to the left.
 i/reset		With i / reset activate the backup process. Display: 1 appears
ca. 8 seconds		After approx. 8 seconds (depending on the duration of the program), the display shows 0 and signals the end of the backup process. Display: 0

Note:



- Before restoring the backup data on the LMV26, the latter compares the burner identification and product no. (ASN) with the burner identification and product no. (ASN) of the backup data set. If the data accord, they are restored. If not, the restore process is aborted. In case of abortion, or if an error occurs during the restore process, the display shows a negative value. For error diagnostics, the cause of the error can be determined from the diagnostic code of error message 137 (see Error code list). When the restore process is successfully completed, value 0 appears on the display. The LMV26 is supplied with undefined burner identification. In that case, the restore process from the AZL2 is possible without having to enter the burner identification in the LMV26.
- Information Err C: 136 D: 1 (restore started) is displayed for a short moment

Caution!

On completion of the restore process, the sequence of functions and the parameter settings must be checked.

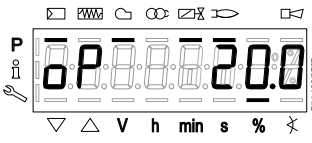

8 Manual performance (manual performance request)

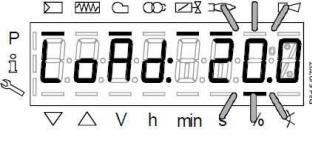
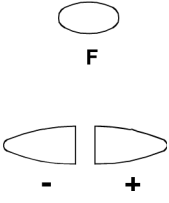
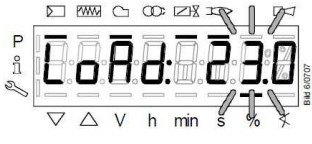
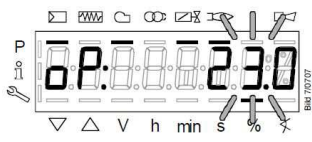
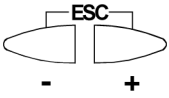
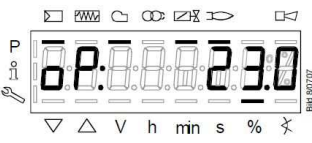
Action button	Display	Description
		<p>The burner is in operation.</p> <p>Display oP: appears on the left, the on the right Percentage of current performance.</p> <p>Example: oP: 20.0</p>
		<p>Hold down the F button for 1 second.</p> <p>LoAd display: appears, the current one Power flashes.</p>
		<p>Use the - or + button to select the desired one Manual output set</p> <p>Example: oP: 23.0</p>
		<p>Release the F button</p> <p>The current manual output flashes to signal that manual mode is active.</p>
		<p>Hold down for 3 seconds with the ESC button you will return to automatic mode.</p> <p>The power no longer flashes.</p> <p>Display oP: appears on the left, the on the right Percentage</p> <p>Example: oP: 23.0</p>

9 Decommissioning

- In the case of a short downtime, e.g. maintenance, de-energise the burner.
- In the case of longer downtimes, switch off the burner and close the gas shut-off devices.

10 Maintenance

The complete system should be checked once a year for proper functioning and leak tightness by an authorised representative of the manufacturer or by another expert.

Only qualified personnel may open only for maintenance, not during on-going operation. Prior to opening/swinging out, de-energise the burner and let it cool down. After completion of work, close the burner again.

Wear protective clothing/hearing protection when working in the boiler house

We accept no liability for consequential damage in cases of incorrect installation or repair, the fitting of non-genuine parts or where the equipment has been used for purposes for which it was not intended.

We recommend a maintenance contract to ensure regular checking.

10.1 Prior to maintenance

- Inform the operator,
- Turn off the gas supply,
- Disconnect the burner voltage.

10.2 Maintenance positions

Maintenance position ventilation wheel / ventilation grille

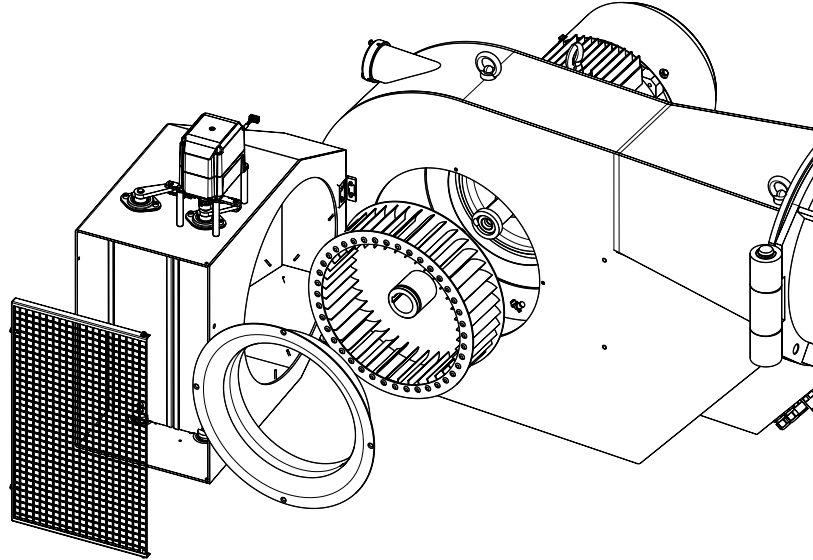

Maintenance position mixer head / electrodes / ignition and ionisation line

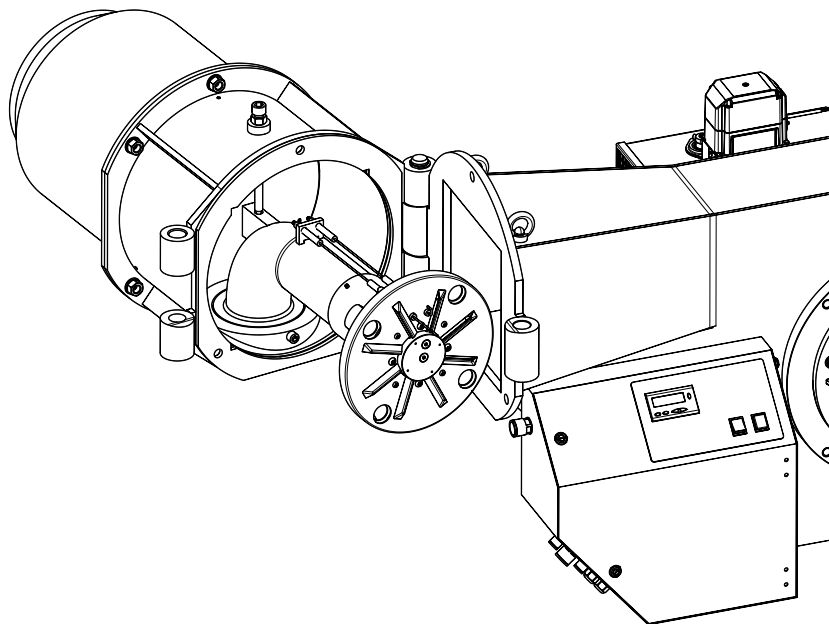

10.3 Maintenance schedule

	Name, Date:		Name, Date:		Name, Date:		Name, Date:	
	OK ✓	NOK Measures	OK ✓	NOK Measures	OK ✓	NOK Measures	OK ✓	NOK Measures
Gas nozzle (clean)								
Diaphragm plate (clean)								
Mixer head (clean)								
Ignition electrodes (clean)								
Ionisation electrode (clean)								
Ignition cable (check for damage)								
Ionisation line (check for damage)								
Gas filter (clean)								
Gas pressure (check)								
Air supply / grille / burner inside casing (clean)								
Fan wheel (check for damage and clean)								
Fresh air supply (check)								

11 Information

11.1 Error code list LMV

loc.C:	loc.d:	Description	Measure
		No communication between basic unit LMV27... and AZL2...	Check wiring for interruptions/ loose contacts
2	1 - 4	No flame at the end of the safety time	
3	0 - 84	Compressed air fault	No compressed air
4	0 - 86	External light	
7	0 - 255	Flame cut-off	
12	0	Fuel valve 1 leaking (fuel valve 2 for leakage check 9)	For leakage check via X5-01 (gas pressure switch min) - Check whether valve on burner side is leaking - Check whether pressure switch for leakage check is closed when gas pressure is applied - Check wiring for short-circuit
	1	Fuel valve 2 leaking (fuel valve 1 for leakage check via X5-01)	For leakage check via X5-01 (gas pressure switch min) - Check whether valve on gas side is leaking - Check wiring for short-circuit
	2- 5	Leakage check not possible	Leakage check activated but no input assigned
	81	V1 leaking	Check whether valve on gas side is leaking Check the wiring for interruptions
	83	V2 leaking	Check whether the valve on the burner side is leaking Check whether the pressure switch for the leak test is closed when gas pressure is applied Check wiring for short-circuit
14	0	POC open	Check whether valve NC contact is closed
	1	POC closed	Check wiring Check whether valve NC contact opens when the valve is activated
	64	POC open start prevention	Check wiring for interruptions Check whether valve NC contact is closed
19	80	Combustion pressure, POC start prevention	Check whether the pressure switch is closed without combustion pressure being present Check wiring for short-circuit
20	0 - 1	Pressure switch min no minimum gas pressure/oil pressure	Check wiring for interruption
21	0- 64	Pressure switch max/POC	Check wiring for interruption. POC: Check whether valve NC contact is closed
22 OFF S	0 - 87	Safety chain	
23	0 - 2	Gas pressure switch min (Pmin)	Check wiring for interruption (X5-01)
50 - 67	#	Internal error	
70	26 - 26	Error group	Set all curve points for gas and air actuators, and for the FC

loc.C:	loc.d:	Description	Measure
71	0 - 3	Special position undefined	Parametrise actuators
75-84		Internal fault group	
85	0	Error group fuel drive	Referencing of fuel drive not successful. Unable to reach reference point. 1. Check whether the drives have been exchanged 2. Check whether the drive is blocked or overloaded
85	1	Error group air drive	Referencing of fuel drive not successful. Unable to reach reference point. 1. Check whether the drives have been exchanged 2. Check whether the drive is blocked or overloaded
86	0 - 1	Error group fuel drive	Unable to achieve the target position within the required tolerance. -> Check whether the drive is blocked or overloaded. A line break was detected at the drive connections. -> Check wiring (voltage X54 between Pin 5 or 6 and Pin 2 >0.5 V).
87	0 - 4	Error air drive	Unable to achieve the target position within the required tolerance. -> Check whether the drive is blocked or overloaded. A line break was detected at the drive connections. -> Check wiring (voltage X53 between Pin 5 or 6 and Pin 2 >0.5 V).
90 - 92	#	Internal fault group	
93	3	Short-circuit of probe	Short-circuit at QRB... 1. Check wiring 2. Flame probe possible defective
95	3 Ignition transformer 4 Fuel valve 1 5 Fuel valve 2 6 Fuel valve 3	External supply NOC	Check wiring
96	3 Ignition transformer 4 Fuel valve 1 5 Fuel valve 2 6 Fuel valve 3	Relay welded	Measure the contacts: 1. Device at voltage: Blower output must be de-energised 2. Deactivated voltage: Disconnect blower. There must be no ohmic connection between blower output and N. If one of the two tests fails, replace the unit, since the contacts are definitely welded and safety can no longer be guaranteed.

loc.C:	loc.d:	Description	Measure
97	0	Safety relay welded or external voltage at safety contact	Measure the contacts: 1. Device at voltage: Blower output must be de-energised 2. Deactivated voltage: Disconnect blower. There must be no ohmic connection between blower output and N. If one of the two tests fails, replace the unit, since the contacts are definitely welded and safety can no longer be guaranteed.
98	2 Safety valve 3 Ignition transformer 4 Fuel valve 1 5 Fuel valve 2 6 Fuel valve 3	Replay does not pick up	Unlock; if it recurs, replace the unit
99 - 250	#	Internal error	
137	#	Internal error– Backup / Restore	
	157 (-99)	Restore – ok, but backup < data set of current	Restore successful, but backup data record is smaller than in the current
	239 (-17)	Backup – storage of backup in AZL2 faulty	Reset and repeat backup
	240 (-16)	Restore – no backup in AZL2	No backup stored in AZL2
	241 (-15)	Restore – abortion due to unsuitable product no. (ASN)	Backup has an unsuitable product no. (ASN) and must not be loaded on the LMV26
	242 (-14)	Backup – backup made is inconsistent	Backup is faulty and cannot be transferred back
	243 (-13)	Backup – data comparison between μ Cs faulty	Reset and repeat backup
	244 (-12)	Backup data are incompatible	Backup data are incompatible with the current software version, restore not possible
	245 (-11)	Access error to parameter Restore_Complete	Reset and repeat backup
	246 (-10)	Restore – timeout when storing in EEPROM	Reset and repeat backup
	247 (-9)	Data received are inconsistent	Backup data record invalid, restore not possible
	248 (-8)	Restore cannot at present be made	Reset and repeat backup
	249 (-7)	Restore – abortion due to unsuitable burner identification	Backup has an unsuitable burner identification and must not be transferred to the LMV26
	250 (-6)	Backup – CRC of one page is not correct	Backup data record invalid, restore not possible
	251 (-5)	Backup – burner identification is not defined	Define burner identification and repeat backup
	252 (-4)	After restore, pages still on ABORT	Reset and repeat backup
	253 (-3)	Restore cannot at present be made	Reset and repeat backup
	254 (-2)	Abortion due to transmission error	Reset and repeat backup

loc.C:	loc.d:	Description	Measure
	255 (-1)	Abortion due to timeout during backup / restore	Make a reset, check the connections and repeat backup / restore In case of repeated backup timeout, the AZL2 does not yet support backup functionality

11.2 Exploded view drawing / spare parts list

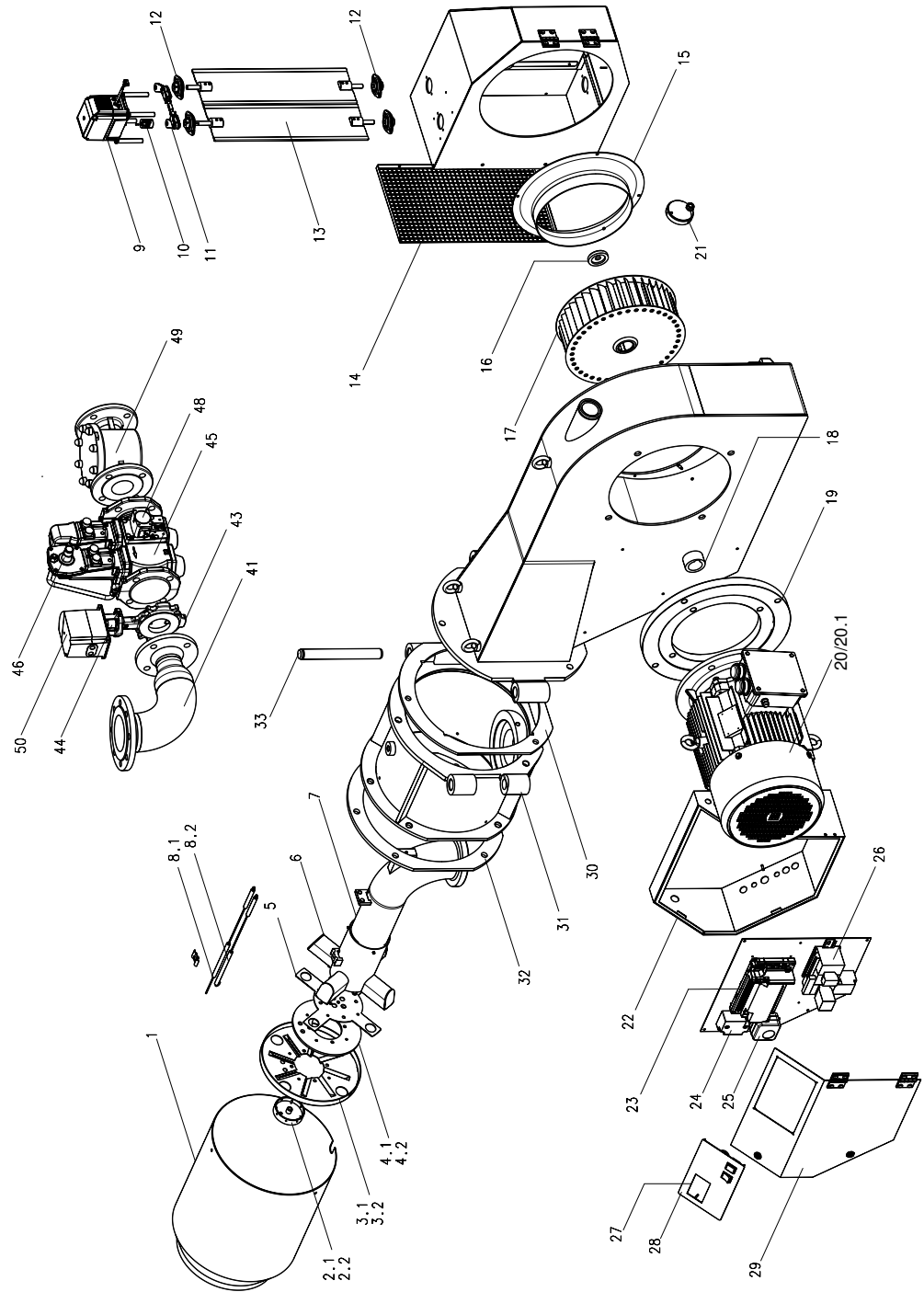

Position	Designation	VE	Art. no.
1	Burner pipe MG40	1	47-90-29072
1	Burner pipe MG40, extended 100 mm	1	47-90-30080
2.1	Primary gas nozzle MG40/1, 8 x Ø3.9	1	47-90-29860
2.2	Primary gas nozzle MG40/2, Ø90, 4 x Ø25, 8 x Ø3.9	1	47-90-29171
3.1	Diaphragm plate MG40/1, 8 slots 6 mm	1	47-90-29859
3.2	Diaphragm plate MG40/2, Ø305 x Ø92, 4 x Ø36	1	47-90-29170
4.1	Spacer MG40/1	1	47-90-29858
4.2	Spacer MG40/2, Ø210 x Ø92 x 6		47-90-29173
5	Gas nozzle cover MG40	1	47-90-29172
6	Gas mixer head MG40	1	47-90-29145
7	Pipe elbow 90° to mixer head	1	47-90-29132
7	Pipe elbow 90° to mixer head, extended 100 mm	1	47-90-30081
8.1	Ionisation electrode D11/D2.5 x 480 mm	1	47-90-29599
8.2	Ignition electrode MG40	1	47-90-30078
-	Ignition and ionization electrode set MG3/30/40		47-90-30172
9	Actuator SQM33	1	47-90-29503
10	Oldham coupling cpl. Ø10/Ø12		47-30-29506
11	Reversing lever		47-90-29494
11.1 oA	ES pin for clevis		47-10-29496
11.2 oA	Clevis size 8 x 32		47-90-29497
11.3 oA	Threaded rod M8		47-90-29495
12	Ball flange nearing		47-90-29464
13	Air flap, one-piece MG40		47-90-29376
13.1 oA	Air flap axle		47-90-29377
13.2 oA	Air flap axle drive		47-90-29378
14	Protective grille, intake box MG40	1	47-90-29134
15	Inflow nozzle ED1/35		47-20-29445
16	Spacer ring 12 motor axle Ø42		47-90-29835
17	Fan wheel Ø355	1	47-90-29444
18	Spacer ring 32 motor axle Ø42		47-90-29836
19	Motor intermediate flange MG40	1	47-90-29375
20	Motor 11 kW, MG40/1	1	47-90-29487
20.1	Motor 15 kW, MG40/2	1	47-90-29486
21	Inspection glass mounting ring MG40		47-30-29845
22	Housing or electrical box MG40	1	47-90-29645
23	Burner management system LMV27.100A2	1	47-90-29079-01
24	Ignition transformer Mod. 26/48	1	47-90-26930
25	Differential pressure switch LGW50	1	44-90-20793
26	Star-delta combination 15 kW	1	47-90-29641
27	Display and operating unit AZL	1	47-90-29098
28	Electrical box cover MG40-LMV27		47-90-29782
29	Hood for electrical box MG40	1	47-90-29658
30	Flange seal between housing and gas jacket		47-90-29489
31	Gas jacket MG40	1	47-90-29054
32	Flange seal, boiler door		47-90-29489
33	Hinge bolt MG40	1	47-90-29101

MG40/1 with DN65

Position	Designation	VE	Art. no.
41	Connection elbow DN100-DN65 with flange	1	47-90-29543
43	Throttle flap DN65		47-90-29820
44	Attachment kit for VKF41	1	47-90-29526
45	SKP set 2.65 consisting of VGD40, SKP15, AGA62, AGA64	1	47-90-26226
46	SKP25, drive for gas valve	1	47-90-29942
48	Gas pressure switch QPL15 5 - 150 mbar cpl.	1	47-90-26764
49	Gas filter DN65 1 bar	1	44-90-23126
50	Actuator SQM 33	1	47-90-29503
-	Flange seal DN100		44-50-23182
-	Flange seal DN65 127 x 77 x 2 mm		44-50-23184
-	Pressure measuring nipple 1/4" Al. with seal	1	47-90-29910

MG40/2 with DN80

Position	Designation	VE	Art. no.
41	Connection elbow DN100-DN80 with flange	1	47-90-29542
43	Throttle flap DN80		47-90-29502
44	Attachment kit for VKF41	1	47-90-29526
45	SKP set 2.80 consisting of VGD40, SKP15, AGA62, AGA64	1	47-90-26229
46	SKP25, drive for gas valve	1	47-90-29942
48	Gas pressure switch QPL15 5 - 150 mbar cpl.	1	47-90-26764
49	Gas filter DN80 1 bar	1	47-90-26599
50	Actuator SQM 33	1	47-90-29503
-	Flange seal DN100		44-50-23182
-	Flange seal DN80		44-50-23181
-	Pressure measuring nipple 1/4" Al. with seal	1	47-90-29910

All information in this technical documentation as well as the drawings, photos and technical descriptions placed at your disposal remain our property and may not be duplicated without our written permission given in advance.
Subject to alterations.



Giersch GmbH • Brenner und Heizsysteme
Adjutantenkamp 18 • D-58675 Hemer • Telephone 02372/965-0 • Telefax 02372/61240
E-Mail: info@giersch.de • Internet: <http://www.giersch.de>