

# MG2-ZM-L

Issued in November 2021  
Subject to tech. modifications  
to improve the product!

**Gas**

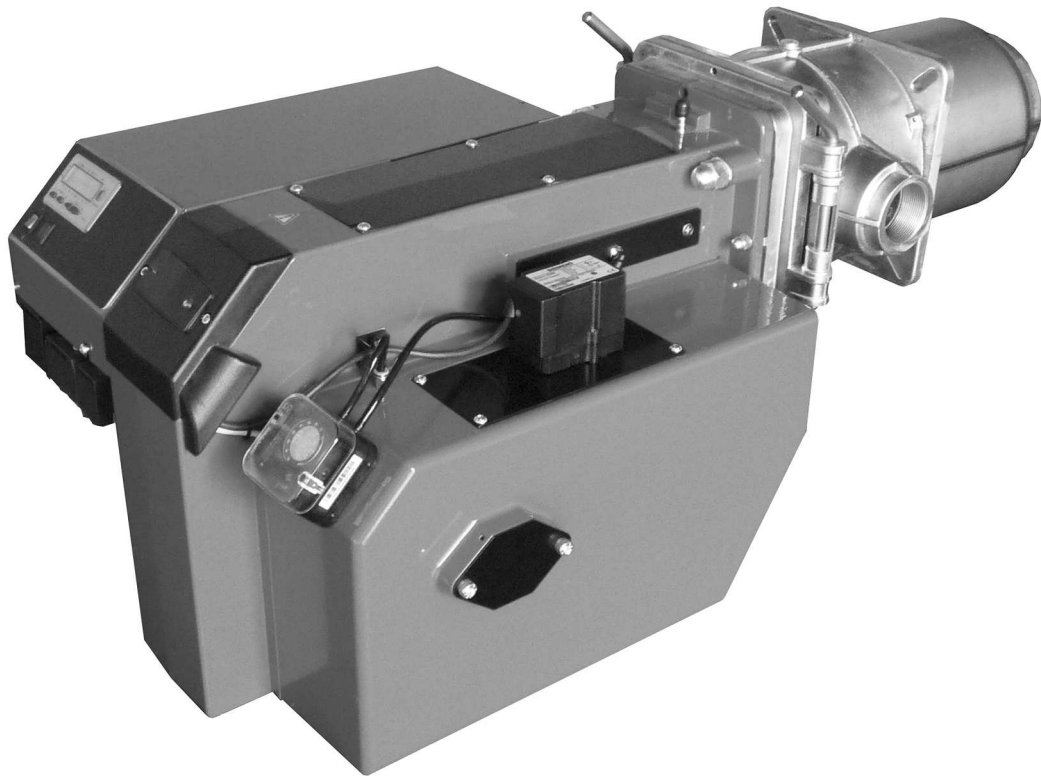

---

## Contents

1	General information .....	3
2	Checking the scope of delivery and electrical ratings .....	3
3	Maintenance and customer service .....	4
4	Operating instructions .....	4
5	Instruction of operating personnel.....	4
6	Key for code designation .....	4
7	Technical specifications .....	5
8	Boiler connection dimensions .....	5
9	Mounting the gas jacket mantel at the boiler .....	5
10	Mounting the burner housing on the gas jacket (service position) .....	6
11	Terminal diagram connector pin assignments .....	7
12	Electrical connection .....	8
13	Air flap positioning motor .....	9
14	Air pressure switch .....	9
15	Gas pressure monitor .....	10
16	Adjusting the ignition electrode .....	11
17	Flame control with ionisation monitor.....	11
18	Connection diagram LMV .....	12
19	Operating instructions and equipment description LMV.....	13
20	Start-up and calibration .....	14
21	Gas burner with gas train KEV <sub>11</sub> 1 ½", KEV 2", KEV412 1 1/2", KEV300 1", KEV DN65 .....	20
22	Calculation principles for gas burner adjustment .....	22
23	Adjustment tables .....	23
24	Error code list LMV .....	24
25	Adjustments log .....	26
26	Exploded view / spare parts list.....	27
27	Declaration of conformity .....	29
28	Overall dimensions .....	30
29	Working range.....	30

## 1 General information

Installation of a gas-fired heating system must be performed in accordance with the applicable regulations and guidelines. It is therefore the duty of the installer to be fully familiar with all regulations. Installation, start-up and maintenance must be performed with utmost care.

The burner must not be operated in rooms with high levels of air humidity (laundry rooms), dust or corrosive vapours. The boiler room must be ventilated accordingly with ventilation air.

MG Series gas burners are suitable for combustion of natural gas in accordance with DIN EN 437 and are in compliance with the DIN EN 676 European standard.

## 2 Checking scope of supply and electrical ratings

Before installing the gas burner, please check the scope of delivery.

Scope of delivery:

burner housing, gas jacket with burner pipe, mounting kit, documentation and gas train.

Gas installation and commissioning are subject to the applicable national regulations, e.g. in Germany the Technical Regulations of the DVGW (DVGW-TR-GI).

The following must be observed for Switzerland: SVGW Gas Provisions G1, G3: Gas installation EKAS Form.

1942: Liquefied gas regulation, Part 2 Regulations of cantonal authorities (e. g. fire department regulations).

The gas pipe must be designed to conform to the flow rate and the available gas flow pressure and routed with the lowest pressure loss over the shortest distance to the burner.

The loss of gas pressure via the gas train and the burner as well as the resistance on the fuel gas side of the heat generator must be less than the connection flow pressure.

### Caution !

**Observe sequence and through-flow direction of valves and fittings.**



### 3 Maintenance and customer service

The complete system should be checked once a year for proper functioning and leak tightness by an authorised representative of the manufacturer or by another expert.

Only qualified personnel may open only for maintenance, not during on-going operation. Prior to opening/swinging out, de-energise the burner and let it cool down. After completion of work, close the burner again.

Wear protective clothing|/hearing protection when working in the boiler house

We accept no liability for consequential damage in cases of incorrect installation or repair, the fitting of non-genuine parts or where the equipment has been used for purposes for which it was not intended.

### 4 Operating instructions

The operating instructions together with this technical information leaflet must be displayed in a clearly visible position in the boiler room. The address of the nearest customer service centre must be displayed on the back of the operating instructions.

### 5 Instruction of operating personnel

Failures are often caused by operator error. The operating personnel must be properly instructed in how the burner works. In the event of recurring faults, Customer Service should be notified.

### 6 Key for code designation

**MG 2-ZM-L-N(F)**

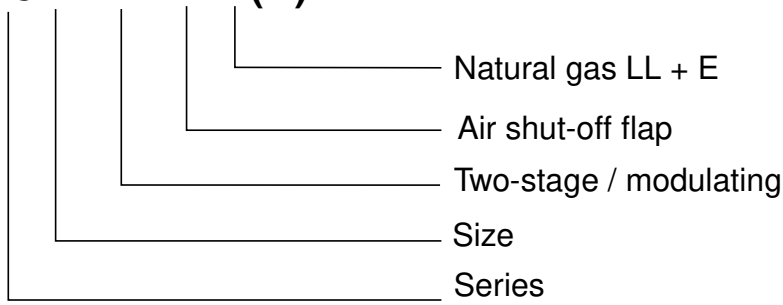

## 7 Technical specifications

	Burner type
<b>Technical data</b>	<b>MG2-ZM-L</b>
Min. burner in kW	230 - 860
Gas type	for natural gas LL + E = "N", LPG = „L“
Method of operating	2-stage sliding / modulating
Voltage	23 / 400 V ~ 50 Hz
max. current consumption start/operatiopn	3.3 A max./ 2.2 A eff.
Electric motor power (at 2800min <sup>-1</sup> ) in kW	1.1
Flame failure controller	Ionisation / UV-sonde
Control box	LMV27
Weight in kg	56
Noise emission in db(A)	≤ 78

## 8 Boiler connection dimensions

Dimensions in mm

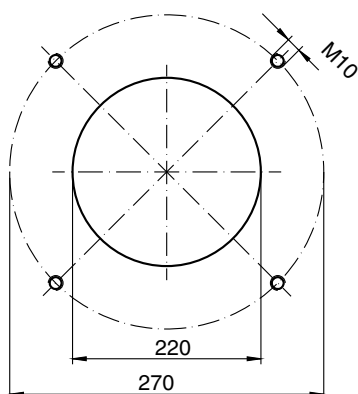

Air pressure connection

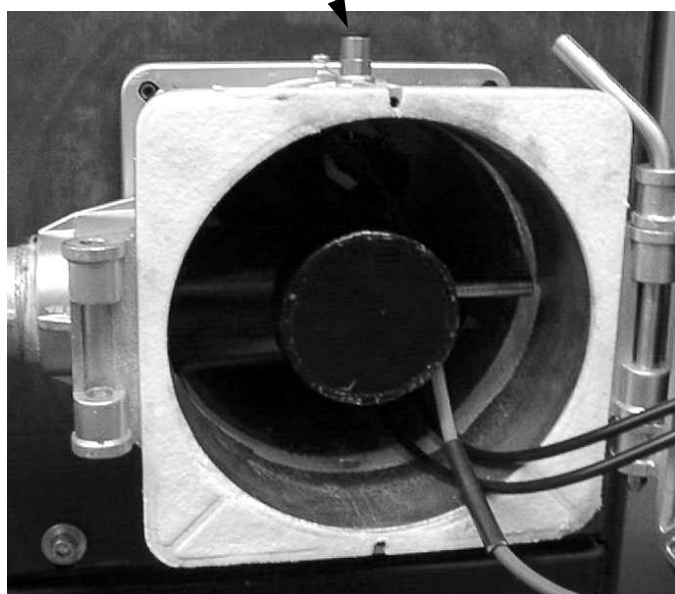

## 9 Mounting the gas jacket on the boiler

The boiler connection plate must be prepared according to the dimensions specified for the boiler connection dimensions. You can use the gas-jacket gasket as a template.

Screw the gas jacket to the boiler using the four M10 fastening screws with washers and a size Allen key. The air pressure switch for the gas train must be at the top.

## 10 Mounting the burner housing on the gas jacket (service position)

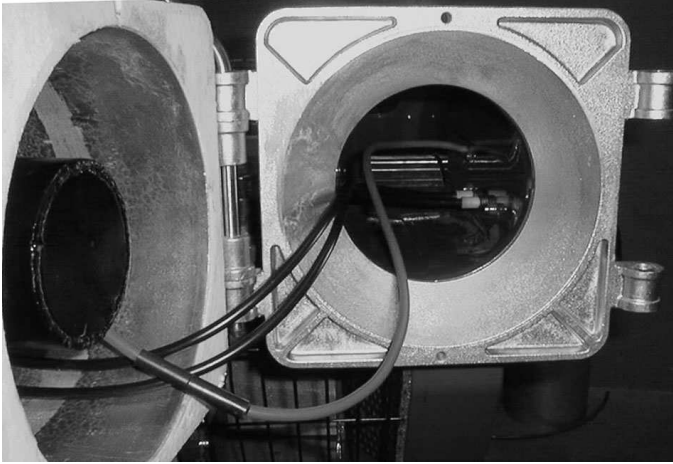

Position the burner housing in the gas-jacket hinge and secure it with a rod. The burner is now in the service position.

Attach the ignition and ionisation cable to the ignition and ionisation electrodes.



**Carefully swing the burner closed.  
Do not pinch electrical cables.**

Insert the second mounting rod into the hinge. Tighten the screw at the top to secure the burner in position.

## 11 Terminal diagram - connector pin assignments



If the male connector has already been wired: check the connections according to the connection diagram!

The electrical connection of the burner must be made in the male connector included according to the connection diagram, taking account of the local regulations.

The supply cable must be fused with max. 10 A fast blow or 6.3 A slow blow and must be routed using flexible cable.

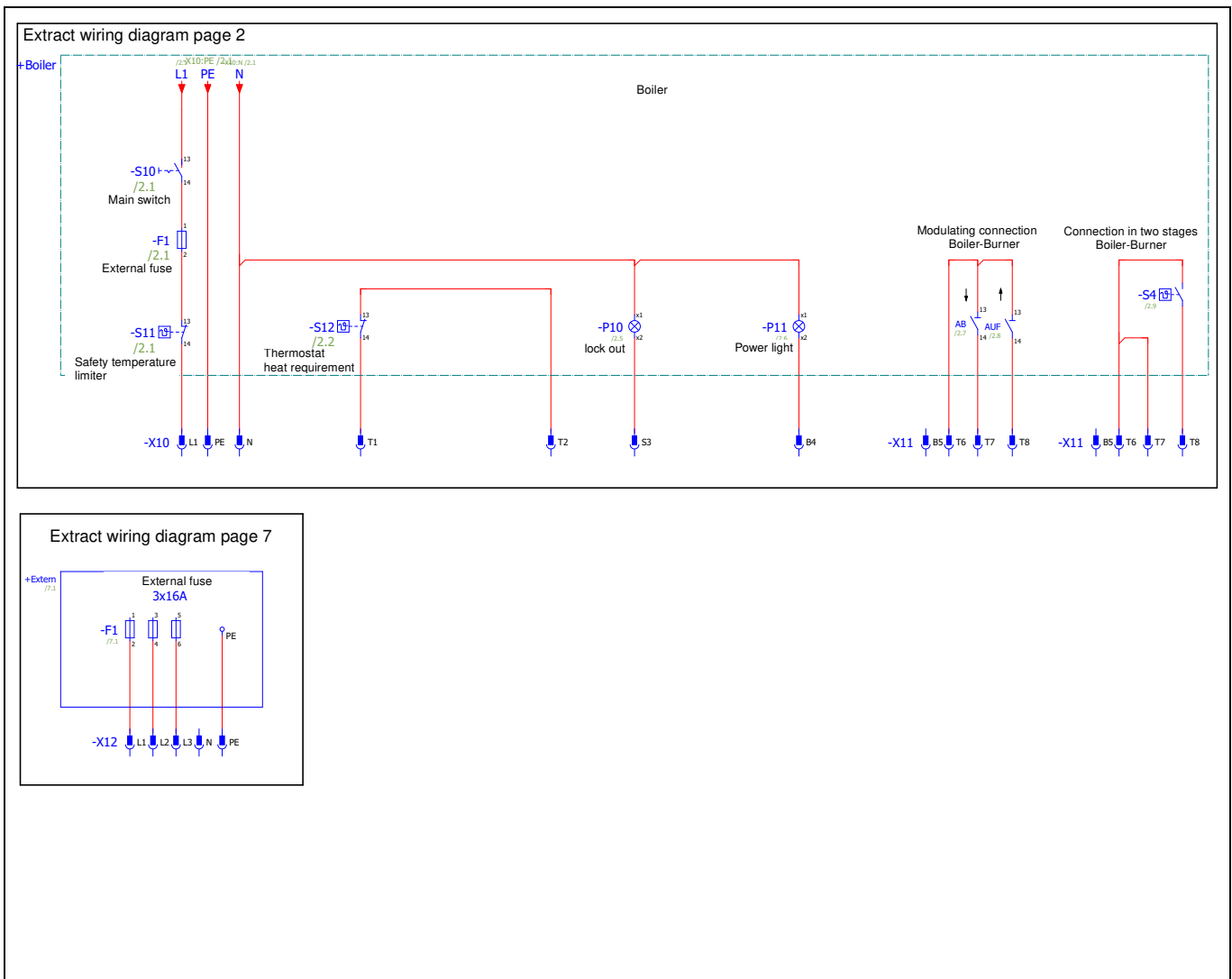

## 12 Electrical connection



**De-energise the burner when carrying out connection work and removing electrical parts!**

The burner must be connected to the electricity supply in accordance with the wiring diagram. This work must be performed by trained, qualified electricians. The supply cable to the burner must be of the flexible type.



To access the firing unit, the cover must be brought to the service position. To do this, remove the securing screws (1) and fold the cover down to the left.

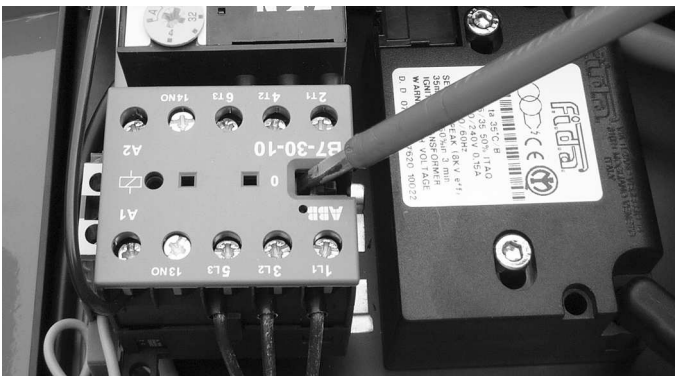

After wiring has been completed, check the direction of rotation of the burner motor.

The direction of rotation is correct when the fan wheel turns towards the boiler (also see arrow on the motor flange).

**IMPORTANT !**



The motor protection relay is set at the factory. The set value should not be modified.



### 13 Air flap positioning motor

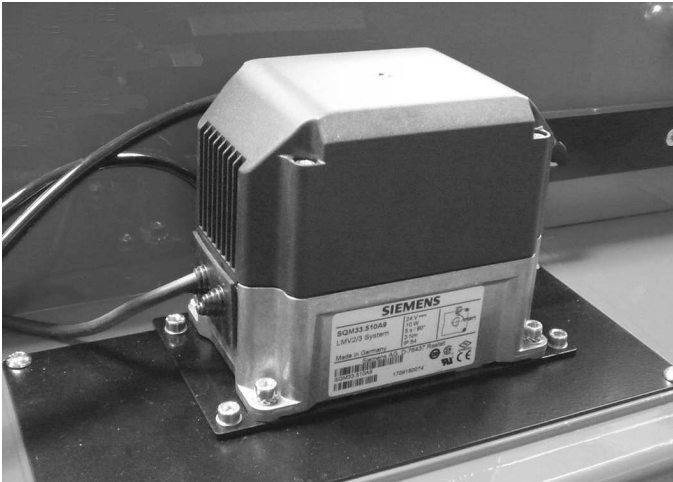

The air flap positioning motor is designed for air flap adjustment on progressive two-stage burners or modulating burners. The motor is activated electronically via the microprocessor-controlled control box.



**Do not open the air flap actuator while it is under voltage. The internal optics would be destroyed. No warranty if the seal is broken!**



### 14 Air pressure monitor

The air pressure switch is a differential pressure switch and monitors the air pressure at the forced-air burner.

The air pressure switch is pre-set at the factory.

## 15 Gas pressure monitor

### 15.1 Gas pressure switch min.



The **gas pressure switch MIN** at the gas fitting serves to monitor the gas inlet pressure. If the minimum gas inlet pressure is not reached (factory setting), the burner is switched off. The burner automatically starts again when the minimum pressure is exceeded. The gas pressure monitor as **density control DK** generally serves to check the valves and must be set to 50% of the static gas inlet pressure.

The monitoring of the gas inlet pressure and the tightness control are carried out either only with the gas pressure switch DK (**the plug bridge GDW MIN must not be removed**) or with the gas pressure switch MIN and the gas pressure switch DK (**in this case the plug bridge GDW MIN must be replaced with the connection of the gas pressure switch MIN**).

When using the MB-VEF 412 gas line, the connection is made via the 7-pin plug and is only evaluated as DK MIN. The plug bridge must not be removed.



**Additional parameterization of the LMV is not required here.**

### 15.2 Gas pressure switch max.

Optionally, a gas pressure switch max. to be built in.

The LMV and the wiring are prepared so far that only the bridge in the socket (brown) on the burner has to be removed. In addition, the plug and the gas pressure switch must be max. Wired according to wiring diagram. If the gas pressure switch max. has triggered a fault in the display (AZL) displayed.

First, the gas pressure switch must be max. be unlocked, the lid of the gas pressure switch must max. unscrewed and the red button pressed.

Then the fault in the display (press the **i / reset** button for 3 sec.) Can be deleted.

## 16 Set the electrodes

The electrodes are preset at the factory.

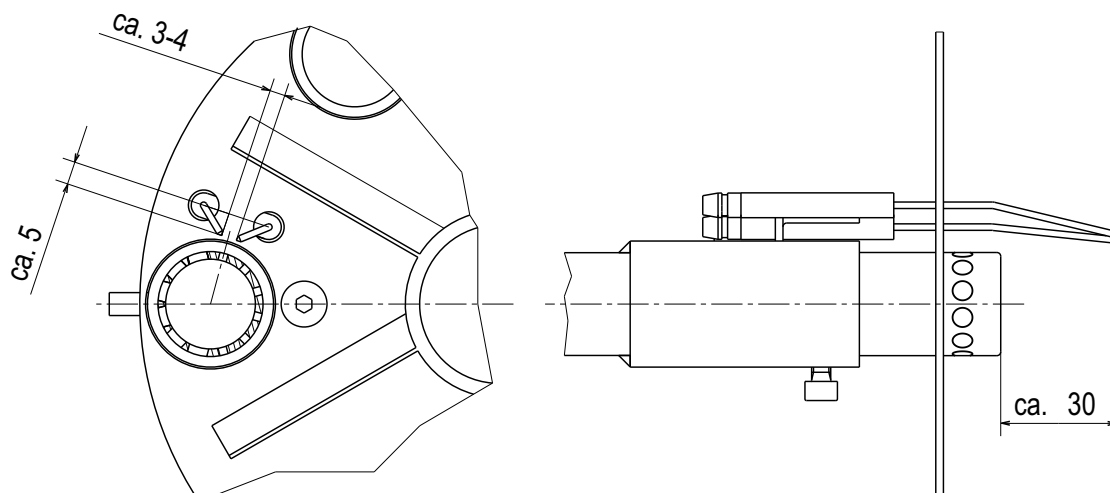

## 17 Flame control with ionisation monitor

### UV-sonde QRA2

The flame monitor is used to monitor gas flames, yellow / blue burning oil flames as well as for ignition spark control

Trouble-free burner operation is only guaranteed if the intensity of the UV radiation at the installation location of the sensor is so great that it reliably ignites during each half-wave.

The intensity of the UV radiation at the installation location of the sensor is checked by measuring the sensor current.

### Measuring ionisation current

The ionisation current must be measured during burner start-up and maintenance or after a fault indication in the control box. Disconnect the plug of the ionisation cable and connect the ionisation measuring cable.

Perform measurement straight after the post-ignition time during the safety time period !

The ionisation current must be at least 1.5  $\mu\text{A}$ . Currents lower than 1.5  $\mu\text{A}$  cause unstable operation or shutdown. If the current is too low clean the ionisation rod and the inside of the burner tube. It may be necessary to correct the shape of the ionisation rod. If the ionisation rod is defective, replace the electrode. Reverse the polarity of the ignition transformer, if necessary. Check the cables for moisture formation and dry if necessary.





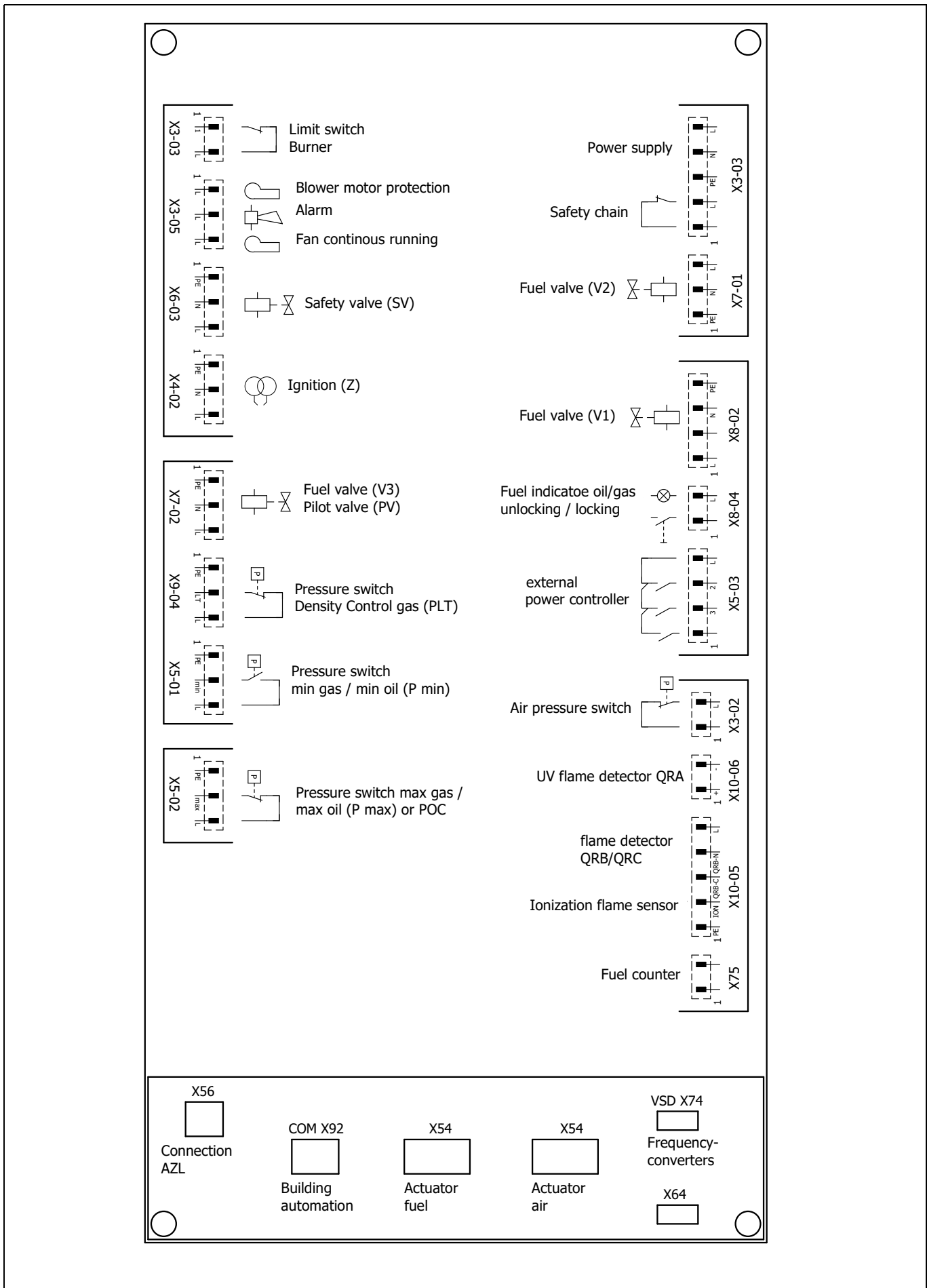

# 18 Connection diagram LMV27

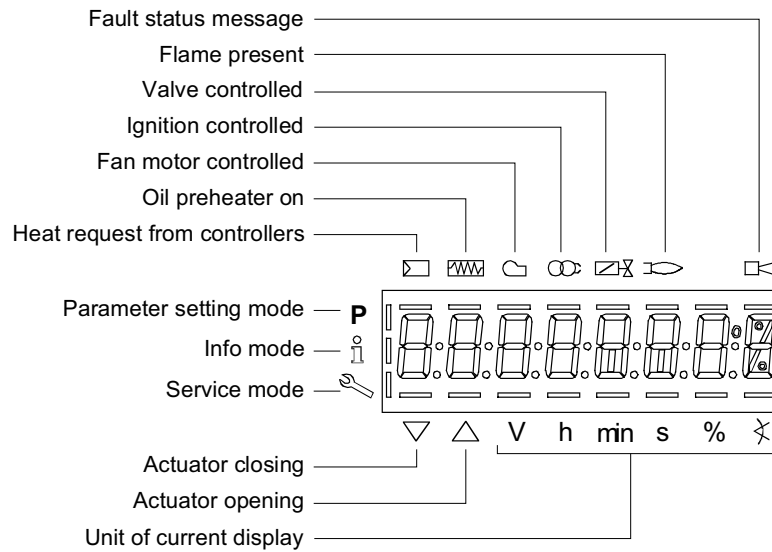

## 19 Operating instructions and equipment description LMV

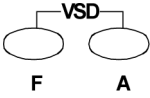
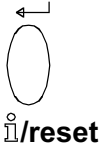

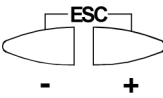
Button	Function
 F	<b>F button</b> - To adjust the fuel drive (Hold down the <b>F button</b> and set the value with the - or + button)
 A	<b>A button</b> - To adjust the air drive (Hold down the <b>A button</b> and set the value with the - or + button)
 F A	<b>F and A button</b> - To shift to parametrisation mode <b>P</b> ( <b>F and A button</b> press simultaneously with - or + button)  - To adjust the speed for frequency converter operation (FC) ( <b>F and A button</b> press simultaneously with - or + button)
 i/reset	<b>Information and enter button</b> - To navigate in information and service mode * Selection (flashing symbol) increment (press button < 1 s) * To switch to a lower menu level (press button < 1 ... 3 s) * To switch to a lower menu level (press button < 3 ... 8 s) * To switch the operating mode (press button > 8 s) - <b>Enter</b> in parametrisation mode - <b>Unlock</b> in case of fault - One menu level down
 -	<b>- Button</b> - Reduce value - For navigating in curve setting, information and service mode
 +	<b>+ Button</b> - Increase value - For navigating in curve setting, information and service mode
 - +	<b>- and + button: Escape function</b> (Press - and + button simultaneously) - Do not accept the value - One menu level higher

## 20 Start-up and calibration

Determine the burner output according to the table on page 23 ff. P0 = Start stage, P1 = 1st stage / min. output, P9 = 2nd stage / max. output.

Normally, P0 = P1. For the condensing boiler, P0 must be set higher than P1. The setting is dependent on the boiler. The mixer head must be set according to the table.



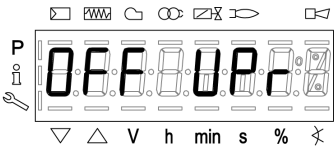
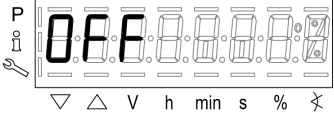

To enter this adjustment mode, the burner must be on standby.

Standby means that the burner is supplied with voltage, gas pressure is built up and there is no demand for heat.

The firing managers are parametrized in the factory. OFF UPr appears in the display during first start-up.

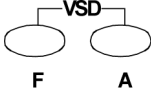
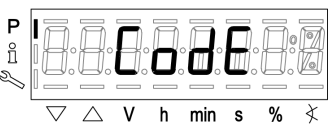
Action button	Display	Description
		<b>OFF UPr</b> means burner off and non-programmed.
		<b>OFF</b> means burner off and programmed.

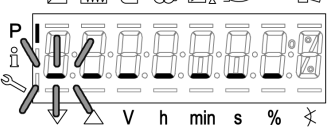

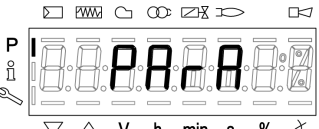
### Enter password

Action button	Display	Description
		Press <b>F and A</b> button simultaneously. The display <b>CodE</b> appears
 		After releasing the buttons, 7 bars appear and the first one flashes. Use the <b>- or +</b> button to select a number or letter. Confirm each value with <b>i/reset</b> .
		Confirm the password <b>1234</b> with <b>i/reset</b> after the last input.
		After correct input, the following appears for a max. of two seconds

## Switch on the burner



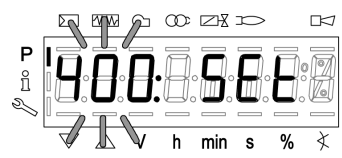

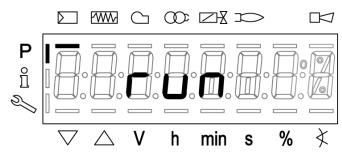
Continuous heat requirement is necessary for further start-up!

### LMV programmed

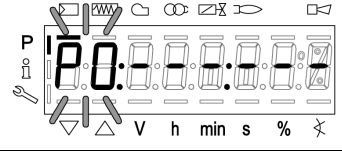

Action button	Display	Description
 <b>i/reset</b>		
 <b>i/reset</b>		<p>When the firing machine is programmed, <b>run</b> is displayed.</p> <p><b>i/reset</b> skips the next steps and continues at the section Start heat settings with curve point <b>P1</b> Small load.</p>

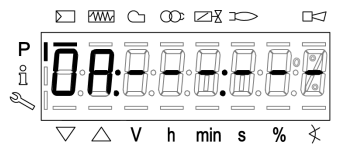
## Start load preset

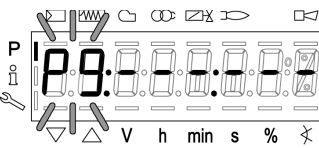
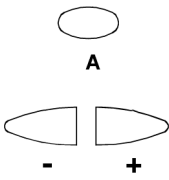
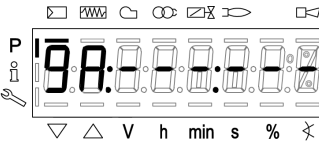

Use the values from the setting tables to preset the values.

Action button	Display	Description
		Set the start position air flap.
 <b>A</b>  <b>- +</b>		Hold down <b>button A</b> and set the value with the <b>- or + button</b> .
 <b>+</b>		Move to the next curve point.

### High load preset

Action button	Display	Description
		Set the high load air flap.
		Hold down <b>button A</b> and set the value with the <b>- or + button</b> .
		Move to the next curve point.

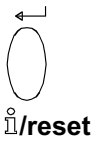
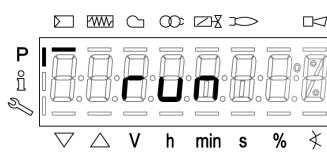
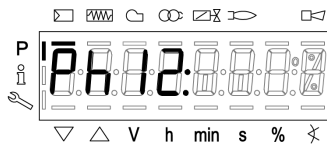
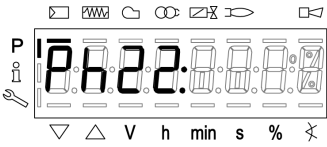
### Start identifier for curve programming - Calibration with flame

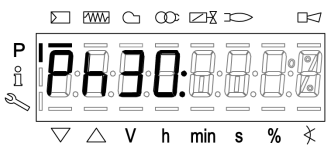







Action button	Display	Description
		When heat demand is present.  Confirm with <b>i/reset button</b> .
		Burner start with pre-ventilation.
		Blower start-up and safety valve ON
		Run in pre-ventilation position
		Pre-ventilation

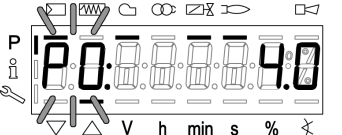
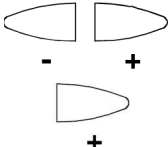

If the leakage check is activated, Ph80, Ph81, Ph82 and Ph83 are displayed first.



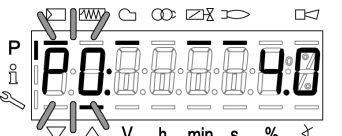



Action button	Display	Description
		Driving in ignition position

## Start heat setting

Action button	Display	Description
 A		The <b>ignition position P0</b> cannot be set until the symbols ▼▲ disappear.
		Hold down <b>A button</b> a set the value with the <b>- or + button</b> . Press <b>+ button</b> to confirm.
		Ignition ON
		Valves ON
		Ignition OFF
		Flame in start position
 A		When transferring <b>P1 to P2</b> for the first time, <b>CALC</b> appears briefly
		The curve points <b>P2 to P9</b> are calculated automatically as a straight line.
 +		Use <b>+ button</b> to confirm all curve points up to curve point <b>P9</b> .  In curve point <b>P9</b> , set the excess air for the high load at the gas train using the adjusting screw <b>"V" or "large flame"</b> . The CO <sub>2</sub> value should be 9-10% for natural gas.

Action button	Display	Description
		Use the <b>- button</b> to select curve point <b>P1</b> .  In curve point <b>P1</b> , set the excess air for the high load at the gas train using the adjusting screw " <b>N</b> " or " <b>small flame</b> ". The CO <sub>2</sub> value should be 9-10% for natural gas.
		Use the <b>+ button</b> to select curve point <b>P9</b> again.  In curve point <b>P9</b> , check the excess air for the high load at the gas train and correct using the adjusting screw " <b>V</b> " or " <b>large flame</b> ".

### Setting the output in high and low-load operation

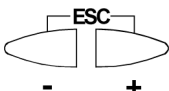
Action button	Display	Description
 		Check the high-load setting via the gas flow at the gas meter or compare the nozzle pressure with the values stated in 24. Adjustment tables.  Hold down <b>A button</b> and use the <b>- or + button</b> to set the output for curve point <b>P9</b> .  The air surplus is not affected by this adjustment.
		Use the <b>- button</b> to select curve point P1.  Check the small-load setting via the gas flow at the gas meter or compare the nozzle pressure with the values stated in 24. Adjustment tables.
		Back to curve point P9
		After setting all curve points, the burner is ready for operation. Press the <b>ESC button</b> briefly 3x to save all curve points and access automatic mode.

**LMV phase display**

<b>Display</b>	<b>Description</b>
Ph00	Fault phase
Ph01	Safety phase
Ph10	Go home
Ph12	Standby (stationary)
Ph22	Blower start-up time (blower motor = ON, safety valve = ON)
Ph24	Run in pre-air position
Ph30	Pre-air time
Ph36	Run in ignition position
Ph38	Pre-ignition phase
Ph39	Leakage check filling time (test pressure switch min for installation between fuel valve 1 and fuel valve 2)
Ph40	First safety time (ignition transformer ON)
Ph42	First safety time (ignition transformer OFF)
Ph44	Interval 1
Ph50	Second safety time
Ph52	Interval 2
Ph60	Operation 1 (stationary)
Ph62	Maximum time small-load setting (operation 2, preparation decommissioning, run in small-load setting)
Ph70	After-burn time
Ph72	Run in post-ventilation position
PH74	Post-ventilation time (no external leak test)
Ph78	Post-ventilation time (abort when power controller ON)
Ph80	Leakage check idle time
Ph81	Leakage check test time atmospheric pressure, atmosphere test
Ph82	Leakage check filling test, filling
Ph83	Leakage check test time gas pressure, pressure test
Ph90	Gas shortage waiting time

## 21 Gas burner with gas train

Installation of the gas train	
Installation position	only in horizontal line, not tilted.
Minimum distance to masonry	20 mm

The nipple for the compressed air connection  $P_L$  must be screwed in at the top of the gas jacket (see 9. Mounting the gas jacket at the boiler).

Connect the blue hose at the "AIR" connection of the gas train and at the air pressure connection at the gas jacket. The blue hose serves as a control line for the gas train and must be routed in a loose loop without kinking.

### Burner start:

If the burner does not go into operation, turn adjusting screw **N** or small flame slightly in the direction "+" and repeat start.

### KEV 1 1/2", KEV2", KEV DN65 (VGD20.40, VGD20.50, VGD40.65 alle SKP15/75)

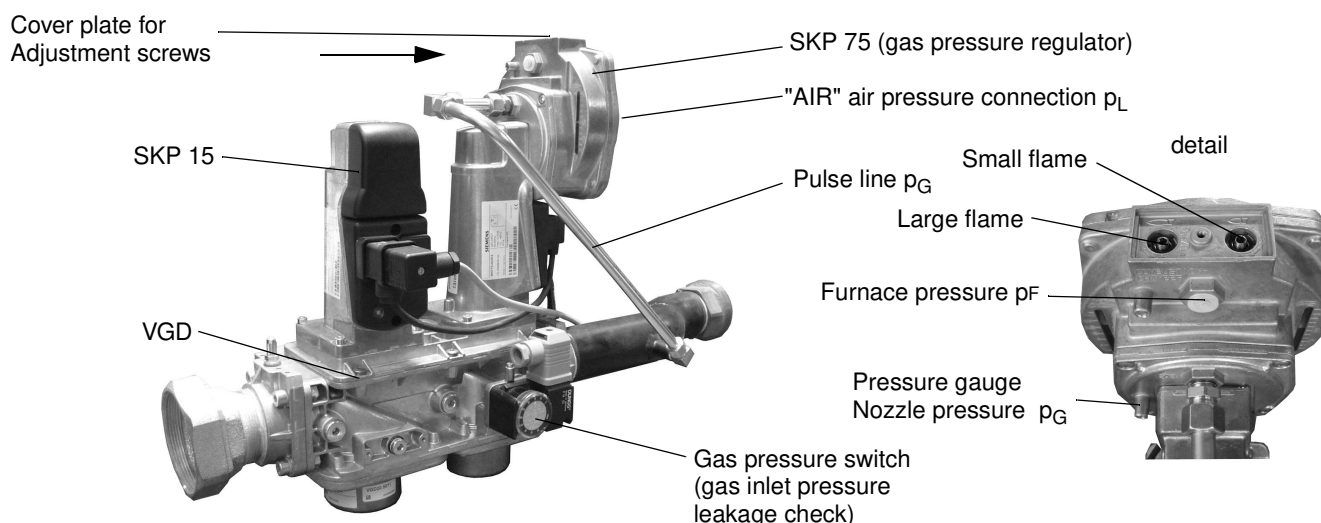

### KEV412 1 1/2"(MB-VEF 412)

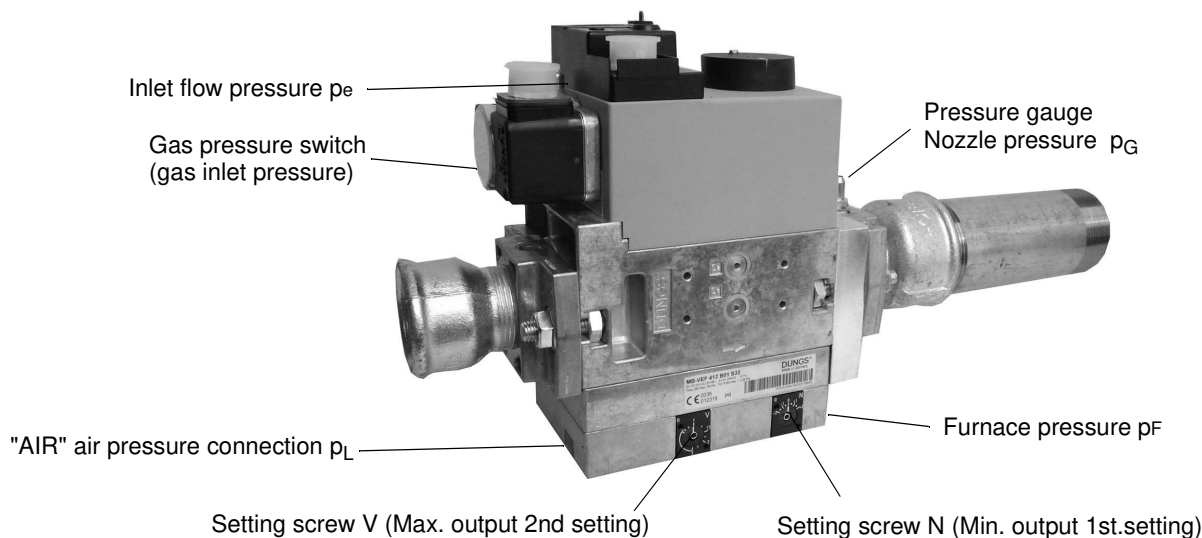

**KEV 300 1" (MBC-300-VEF)**

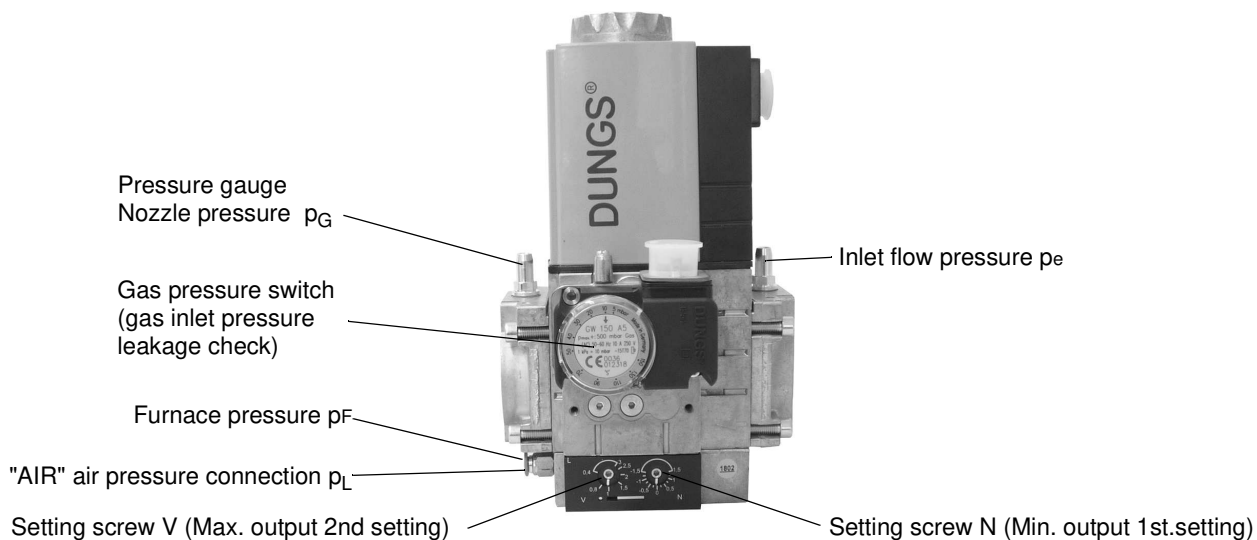

Large flame / "V" setting	Exhaust gas analysis values	
Change in "+" direction if:	CO <sub>2</sub> too low	O <sub>2</sub> too high
Change in "-" direction if:	CO <sub>2</sub> too high	O <sub>2</sub> too low

Small flame / "N" setting	Exhaust gas analysis values	
Change in "+" direction if:	CO <sub>2</sub> too low	O <sub>2</sub> too high
Change in "-" direction if:	CO <sub>2</sub> too high	O <sub>2</sub> too low



**Caution !**  
 Difference between baffle plate pressure  $p_L$  - furnace pressure  $p_F$  must be at least 0.3 mbar.

## 22 Calculation principles for gas burner adjustment

The values given in the tables are setting values for start-up.  
The necessary system adjustment must be newly determined in each case.

### General:

The calorific value ( $H_{i,n}$ ) of fuel gases is generally specified for the normal state (0°C, 1013 mbar).

Natural gas type E	$H_{i,n} = 10.4 \text{ kWh/m}^3$
Natural gas type LL	$H_{i,n} = 9.3 \text{ kWh/m}^3$

Gas counters measure the volume of gas in the operational state.

### Gas flow determination:

To allow the heat generator load to be adjusted correctly, the gas flow rate must be determined in advance.

### Example:

Height above sea level	230 m
Atmospheric pressure B (acc. to Tab.)	989 mbar
Gas pressure $P_G$ at gas meter	20 mbar
Gas temperature $\vartheta_G$	16°C
Boiler output $Q_n$	220 kW
Efficiency $\eta_K$ (assumed)	92%
Calorific value $H_{i,n}$	10.4 kWh/m <sup>3</sup>

### Gas flow in standard state ( $V_n$ )

$$V_n = \frac{Q_n}{\eta_K \times H_{i,n}} = \frac{220 \text{ kW}}{0,92 \times 10,4 \frac{\text{kWh}}{\text{m}^3}} = 23 \frac{\text{m}^3}{\text{h}}$$

### Gas flow in operating state ( $V_B$ )

$$V_B = \frac{V_n}{f} = \frac{23 \frac{\text{m}^3}{\text{h}}}{0,94} = 24 \frac{\text{m}^3}{\text{h}}$$

### Conversion factor (f)

$$f = \frac{B + P_G}{1013} \times \frac{273}{273 + \vartheta_G}$$

### Annual average air pressure

Average geodetic altitude of the supply region above sea level [m]	from		1	51	101	151	201	251	301	351	401	451	501	551	601	651	701
	to	0	50	100	150	200	250	300	350	400	450	500	550	600	650	700	750
Annual average of air pressure	(mbar)	1016	1013	1007	1001	995	989	983	977	971	965	959	953	947	942	936	930

### Legend:

$Q_n$ =	boiler output [kW]
$\eta_K$ =	efficiency [%]
$H_{i,n}$ =	lower standard calorific value [kWh/m <sup>3</sup> ]
f =	conversion factor
B =	atmospheric pressure [mbar]
$p_G$ =	gas pressure at gas meter [mbar]
$\vartheta_G$ =	gas temperature at gas meter [°C]

## 23 Adjustment tables



The values given in the tables are only setting values for start-up. The necessary system adjustment must be newly determined in the case of deviating data such as boiler output, calorific value and altitude.

**A correction is required in any case.**

		Natural gas LL: $H_{i,n} = 9.3 \text{ [kWh/m}^3\text{]}$					Natural gas E: $H_{i,n} = 10.4 \text{ [kWh/m}^3\text{]}$						
Burner output <b>MG2-ZM-L-N</b>		Boiler output $\eta_k = 92\%$	Gas nozzle pressure		Gas throughput		Gas nozzle pressure		Gas throughput		Position air flap		
St. 2	St. 1	Stage 2	St. 2	St. 1	St. 2	St. 1	St. 2	St. 1	St. 2	St. 1	2. St. P9	1.St. P1	
[kW]	[kW]	[kW]	[mbar]	[mbar]	[m <sup>3</sup> /h]	[m <sup>3</sup> /h]	[mbar]	[mbar]	[m <sup>3</sup> /h]	[m <sup>3</sup> /h]	[°]	[°]	
330	230	297	2,3	1,2	38,1	26,5	1,6	0,8	35,6	24,8	15	8	
430	300	387	3,9	2,0	49,6	34,6	2,7	1,4	46,4	32,4	22	13	
570	400	513	6,3	3,2	65,8	46,1	4,3	2,2	61,5	43,1	29	20	
710	500	639	10,3	5,0	81,9	57,7	7,1	3,8	76,6	53,9	40	25	
860	600	774	15,4	7,0	99,2	69,2	10,6	4,8	92,6	64,7	70-90	31	

		LPG: $H_{i,n} = 25,89 \text{ [kWh/m}^3\text{]}$							
Burner output <b>MG2-ZM-L-F</b>		Boiler output $\eta_k = 92\%$	Gas nozzle pressure		Gas throughput		Position air flap		
Stage 2	Stage 1	Stage 2	Stage 2	Stage 1	Stage 2	Stage 1	Stage 2 P9	Stage 1 P1	
[kW]	[kW]	[kW]	[mbar]	[mbar]	[m <sup>3</sup> /h]	[m <sup>3</sup> /h]	[°]	[°]	
330	230	297	3,7	1,8	13,7	9,6	15	8	
430	300	387	6,3	3,1	17,9	12,5	22	13	
570	400	513	11,2	5,5	23,7	16,6	29	20	
710	500	639	17,3	8,6	29,5	20,8	40	25	
860	600	774	25,4	12,4	35,7	24,9	90	31	

## 24 Error code list LMV

loc.C:	loc.d:	Description	Measure
		No communication between basic unit LMV27... and AZL2...	Check wiring for interruptions/loose contacts
2	1 - 4	No flame at the end of the safety time	
3	0 - 84	Compressed air fault	No compressed air
4	0 - 86	External light	
7	0 - 255	flame cut-off	
12	0	Fuel valve 1 leaking (fuel valve 2 for leakage check 9	For leakage check via X5-01 (gas pressure switch min) - Check whether valve on burner side is leaking - Check whether pressure switch for leakage check is closed when gas pressure is applied - Check wiring for short-circuit
	1	Fuel valve 2 leaking (fuel valve 1 for leakage check via X5-01)	For leakage check via X5-01 (gas pressure switch min) - Check whether valve on gas side is leaking - Check wiring for short-circuit
	2- 5	Leakage check not possible	Leakage check activated but no input assigned
	81	V1 leaking	Check whether valve on gas side is leaking Check the wiring for interruptions
	83	V2 leaking	Check whether the valve on the burner side is leaking Check whether the pressure switch for the leak test is closed when gas pressure is applied Check wiring for short-circuit
14	0	POC open	Check whether valve NC contact is closed
	1	POC closed	Check wiring Check whether valve NC contact opens when the valve is activated
	64	POC open start prevention	Check wiring for interruptions Check whether valve NC contact is closed
19	80	Combustion pressure, POC start prevention	Check whether the pressure switch is closed without combustion pressure being present Check wiring for short-circuit
20	0 - 1	Pressure switch min no minimum gas pressure/oil pressure	Check wiring for interruption
21	0- 64	Pressure switch max/POC	Check wiring for interruption. POC: Check whether valve NC contact is closed
22 OFF S	0 - 87	Safety chain	
23	0 - 2	Gas pressure switch min (Pmin)	Check wiring for interruption (X5-01)
50 - 67	#	Internal error	
70	26 - 26	Error group	Set all curve points for gas and air actuators, and for the FC
71	0 - 3	Special position undefined	Parametrise actuators
75-84		Internal fault group	
85	0	Error group fuel drive	Referencing of fuel drive not possible. Unable to reach reference point. 1. Check whether the drives have been exchanged 2. Check whether the drive is blocked or overloaded



loc.C:	loc.d:	Description	Measure
85	1	Error group air drive	Referencing of fuel drive not successful. Unable to reach reference point. 1. Check whether the drives have been exchanged 2. Check whether the drive is blocked or overloaded
86	0 - 1	Error group fuel drive	Unable to achieve the target position within the required tolerance. -> Check whether the drive is blocked or overloaded. A line break was detected at the drive connections. -> Check wiring (voltage X54 between Pin 5 or 6 and Pin 2 >0.5 V).
87	0 - 4	Error air drive	Unable to achieve the target position within the required tolerance. -> Check whether the drive is blocked or overloaded. A line break was detected at the drive connections. -> Check wiring (voltage X53 between Pin 5 or 6 and Pin 2 >0.5 V).
90 - 92	#	Internal fault group	
93	3	Short-circuit of probe	Short-circuit at QRB... 1. Check wiring 2. Flame probe possible defective
95	3 Ignition transformer 4 Fuel valve 1 5 Fuel valve 2 6 Fuel valve 3	External supply NOC	Check wiring
96	3 Ignition transformer 4 Fuel valve 1 5 Fuel valve 2 6 Fuel valve 3	Relay welded	Measure the contacts: 1. Device at voltage: Blower output must be de-energised 2. Deactivated voltage: Disconnect blower. There must be no ohmic connection between blower output and N. If one of the two tests fails, replace the unit, since the contacts are definitely welded and safety can no longer be guaranteed.
97	0	Safety relay welded or external voltage at safety contact	Measure the contacts: 1. Device at voltage: Blower output must be de-energised 2. Deactivated voltage: Disconnect blower. There must be no ohmic connection between blower output and N. If one of the two tests fails, replace the unit, since the contacts are definitely welded and safety can no longer be guaranteed.
98	2 Safety valve 3 Ignition transformer 4 Fuel valve 1 5 Fuel valve 2 6 Fuel valve 3	Replay does not pick up	Unlock; if it recurs, replace the unit
99 - 250	#	Internal error	

## 25 Adjustments log

Please enter the measured values into the Adjustments log.

Boiler type	Gas fitting

Measured values		min.	max.	Date
P0 (start point)				
P1 (min load)				
P9 (max load)				
Flue gas temperature	°C			
Carbon dioxide (CO <sub>2</sub> level)	%			
O <sub>2</sub> content	%			
CO level	%			
Flue	mbar			
Nozzle pressure	mbar			
Boiler pressure	mbar			
Room temperature	°C			
Gas type				
Setting value <b>V</b> at the fitting				
Setting value <b>N</b> at the fitting				

## 26 Exploded view drawing / spare parts list

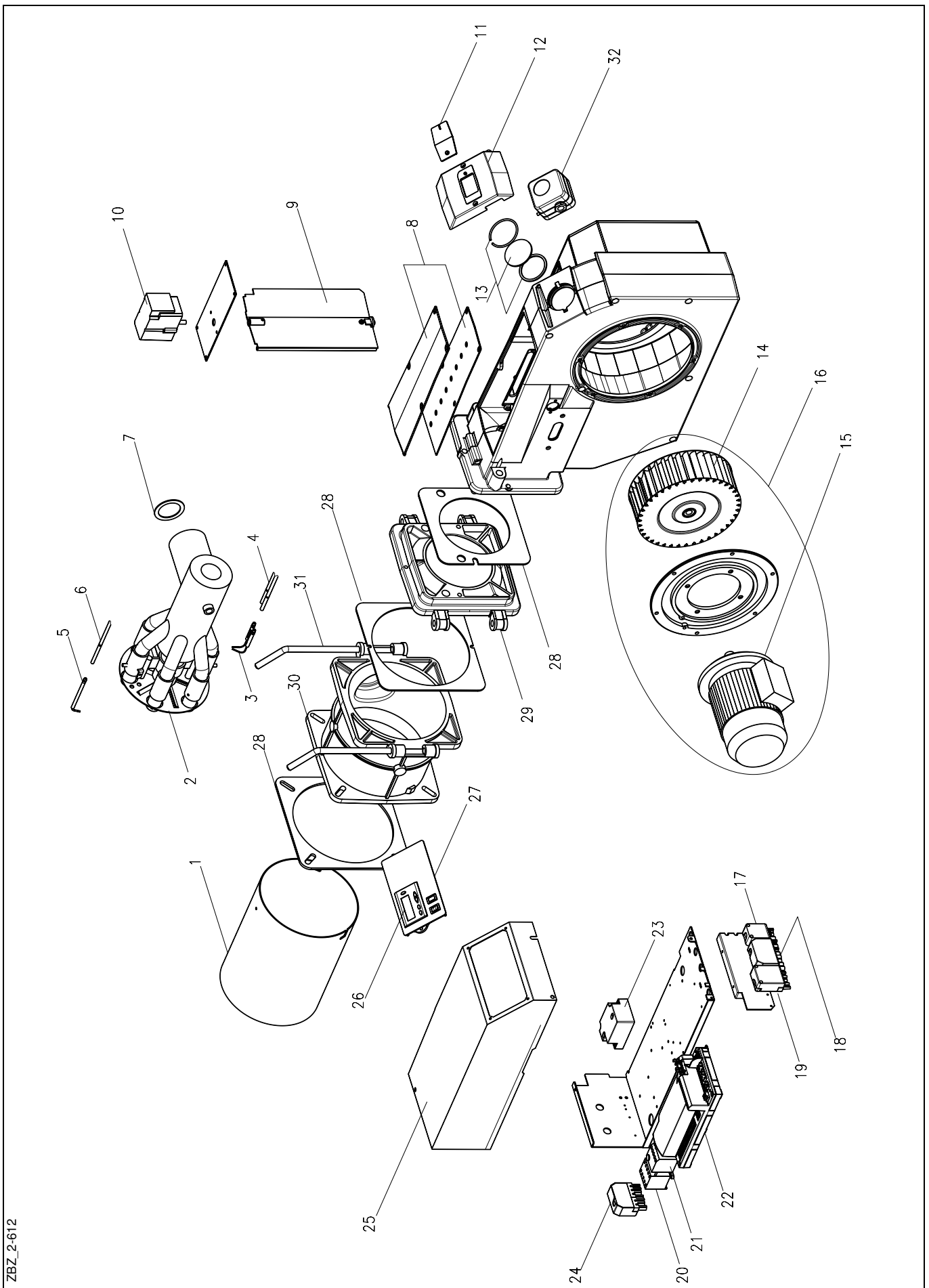

ZBZ\_2-612

Position	Designation	VE	Art. no
1	Burner tube MG2 kpl.		46-90-11907
1	Burner tube MG2 kpl. 100 mm extended	1	46-90-12033
1	Burner tube MG2 kpl. 200 mm extended	1	46-90-12034
2	Gas nozzle MG2-N cpl. with ignition electrode	1	36-90-11930
2	Gas nozzle MG2-N cpl. with ignition electrode extended 100 mm	1	36-90-11934
2	Gas nozzle MG2-N cpl. with ignition electrode extended 200 mm	1	36-90-12062
2	Gas nozzle MG2-F cpl. with ignition electrode	1	36-90-11931
2	Gas nozzle MG2-F cpl. with ignition electrode extended 100 mm	1	36-90-12696
2	Gas nozzle MG2-F cpl. with ignition electrode extended 200 mm	1	36-90-24749
3	Ignition electrode	5	36-50-10127
4	Ignition cable	2	47-50-25134
4	Ignition cable extended 100 mm	2	47-50-25004
4	Ignition cable extended 200 mm	2	47-50-25005
5	Ionization electrode	1	57-90-20137
6	Ionization cable	1	47-90-26718
6	Ionization cable extended 100 mm	1	47-90-26719
6	Ionization cable extended 200 mm	1	47-90-26720
7	Seal for gas nozzle	5	47-50-25521
8	cover with seal	1	47-90-10698
9	Air flap MG20	1	47-90-27030
10	Positioning drive SQN33	1	47-90-29097
11	Sight glass cover	5	47-50-12106
12	Hood	1	47-90-24857
13	Inspection glass with seal	1	36-90-11544
14	Fan wheel Ø 224 x 82	1	47-90-24847
15	Motor 2,2 kW 400 V/ 50Hz	1	47-90-29691
16	Motor 2,2 kW 400 V/ 50Hz with fan wheel	1	47-90-29692
17	Socket part 4-pin. green	1	37-90-20744
18	Socket part 7-pin. black / brown	1	37-90-20731
19	Socket part 5-pin. black	1	37-90-20748
20	Small motor contactor B7-30-10	1	47-90-25171
21	thermal overcurrent relay 4.0 - 6.0 A.	1	47-90-25173
22	Burner management system LMV27 100 A2	1	47-90-29079-02
23	Ignition transformer Mod. 26/35	1	47-90-24469
24	Socket part 7-pin. green	1	37-90-10831
25	Electric box hood	1	47-90-24852
26	Display and control panel AZL 21.00A9	1	47-90-29098
27	Cover	1	47-90-24887
28	Gasket set	1	47-90-26722
29	Gas jacket MG20 Part 2	1	44-90-30242
30	Gas jacket MG20 Part 1	1	44-90-30242
31	Fastening rod	2	46-50-21085
32	Differential pressure switch 2.5 - 50 mbar	1	47-90-26723
-	Inlet nozzle	1	36-90-11541
-	Protective grille	1	47-90-10696
-	Bridging plug part 3-pin. brown gas max.	1	47-90-27382
-	Bridging plug part 3-pin. black gas min	1	47-90-27399
-	Socket part 3-pin. Brown	1	47-90-27203
-	Socket part 3-pin. black	1	37-90-20739
-	UV Sonde QRA 2	1	37-90-11775

## 27 Declaration of conformity



Enertech GmbH, Postfach 3063, 58662 Hemer

© 0 23 72/965-0 ☎ 0 23 72/6 1240 ✉ info@giersch.de 🌐 www.giersch.de

## Declaration of Conformity for Gas Burners

We, Enertech GmbH, Adjutantenkamp 18 in D-58675 Hemer declare under our responsibility that

gas burner type **MG2...**

is conform with the regulations of these directives

MD2006/42/EG

EMC2014/30/EU

GAD 2016/426/EU

LVD2014/35/EU

MCP2015/2193/EU

RoHS 2011/65/EU

DIN EN 676

and is marked with:



CE-0085

Hemer, 15.01.2018

ppa.

*ppa. Dr. Josef Wendel*  
Wendel  
Sales director

i.V.

*R. Rebbe*  
Rebbe  
Technical management

ART-Nr. 89-10-80875 Druck-Nr. 4/2017

Geschäftsführer  
Dr. Josef Wrobel

Amtsgericht Iserlohn  
HRB 8776  
Ust-IdNr.  
DE 215685210

Hausanschrift  
Adjutantenkamp 18.  
58675 Hemer

Lieferanschrift  
An der Iserkuhle 27  
58675 Hemer

Bankverbindung  
ENERTECH GmbH  
IBAN: DE44 2032 0500 4989 1886 07  
BIC: PARAG3333

## 28 Dimensions

(all dimensions are given in mm)

ZBZ\_2-292

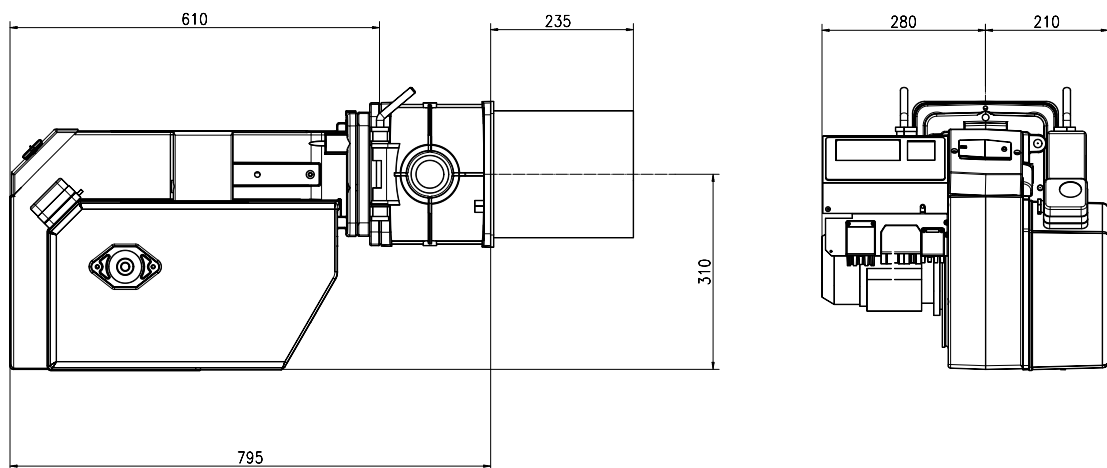

## 29 Working range

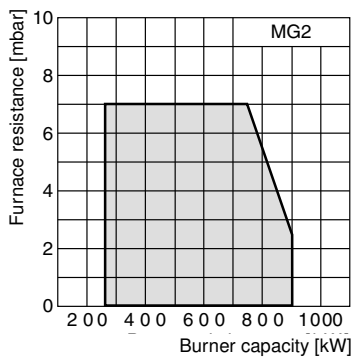

Working range acc. to DIN EN 676. The working range is referred to 15°C and 1013 mbar.

All information in this technical documentation as well as the drawings, photos and technical descriptions placed at your disposal remain our property and may not be duplicated without our written permission given in advance.  
Subject to alterations.

# GIERSCH

Enertech GmbH • Brenner und Heizsysteme  
Postfach 3063 • D-58662 Hemer • Telephone 02372/965-0 • Telefax 02372/61240  
E-Mail: [info@giersch.de](mailto:info@giersch.de) • Internet: <http://www.giersch.de>